





## PAVETEST, A DIVISION OF MATEST

---

**Pavetest is the division of Matest committed to developing innovative, dynamic and static testing systems for asphalt.**

With many years of experience in developing pavement testing systems between them, Con Sinadinos (Managing Director) and Alan Feeley (Technical Director) bring a wealth of experience and talent to the company.

Con commenced his career with the Australian Road Research Board (ARRB) and in 1991 continued as Chief Engineer at IPC Global, where he was promoted to General Manager several years later. Con's involvement in a number of National Cooperative Highway Research Program (NCHRP) projects has given him a great deal of knowledge and experience in the field of flexible pavement.

The benefit is evident in every aspect of every product, which are designed to perform, built to last and easy to use.

From its inception, Pavetest's aim is to develop a range of **testing systems with unparalleled performance, ultimate versatility and exceptional reliability, at a price that represents real value for money.**

Pavetest's range of pavement testing systems both complements and completes Matest's Asphalt and Bitumen business unit.

**MATEST**  
INNOVATIVE. GLOBAL. MANUFACTURER.

**PAVETEST**  
WHERE TECHNOLOGY MEETS THE PAVEMENT.

**STEELTEST**

*tecnotest*  
MATERIAL TESTING EQUIPMENT



## CDAS CONTROL AND DATA ACQUISITION SYSTEM

Pavetest's compact Control and Data Acquisition System (CDAS) delivers unparalleled performance, real time control and ultimate versatility in acquisition and provide a flexible and user friendly testing solution.

**It provides excellent waveform fidelity from integrated acquisition and control functions, with low level sampling at speeds of up to 192,000 samples per second simultaneously on all channels and 20 bit resolution over the full dynamic input signal range.**

### MAIN FEATURES

- Directly communicates with the TestLab software, providing automatic test execution and data processing.
- Compact high reliability data acquisition and control.
- Up to 5 kHz data acquisition and feedback control provides excellent waveform fidelity.
- Up to 64 times oversampling gives superior low noise performance.
- Normalized ( $\pm 10$  V) analog data acquisition inputs provide flexibility to use any transducer in any channel.



**B206** CDAS 16 channels

### EASY DATA PROCESSING WITH THE INCLUDED SOFTWARE

The CDAS includes the TestLab software - supplied on USB flash drive - complete with relevant Method files (based on the test configurations supplied) and calibration files for all the transducers supplied. Software and test methods are expandable for future requirements.

### AVAILABLE MODELS

#### B205

**8 Channel CDAS** - Acquisition 8 CH, 20 bit resolution

- Sampling rate up to 192 kHz (all channels)
- Smoothing up to 64 times over-sampling
- Calibration Automatically on power up
- Control Axis 2
- Communication USB or Ethernet

#### B206

**16 Channel CDAS** - Acquisition 16 CH, 20 bit resolution

- Sampling rate up to 192 kHz (all channels)
- Smoothing up to 64 times over-sampling
- Calibration Automatically on power up
- Control Axis 4
- Communication USB or Ethernet

**Dimensions:** 110(h) x 325(d) x 265(w) mm

**Power Supply:** 90-264V 50-60Hz 1ph 240W

**Weight:** 5 kg approx.

### TECHNICAL FEATURES

#### CONTROL:

- High speed, (18 bit) digital servo-control, up to 4 axis.
- Digital closed loop update sampling rate of 2.5 kHz.
- Computer programmable, Proportional, Integral and Derivative (PID) control algorithm.
- Adaptive Level Control (ALC) algorithm for best dynamic peak accuracy.
- 3 feedback control modes. E.g. force, position and on-specimen strain.
- "Bumpless transfer" between control modes.

#### ACQUISITION:

- Analog inputs are automatically calibrated on power up.
- Simultaneous sampling of all channels.
- 16 Analog ( $\pm 10$  Volt) input channels.
- Up to 64 times over sampling (set to 8 by default).
- 20 bit digital resolution (**approx. 1/1.000.000**), no auto ranging required.
- Sampling rate up to 192.000 samples/see.

## TESTLAB SOFTWARE

Developed with ultimate flexibility in mind, TestLab test and control software caters to all levels of operator experience. By using pre-programmed **Method files**, an inexperienced operator can run a range of international test methods without the need for any programming. Moreover, a test **Wizard**, available with popular tests, can guide the operator step by step based on a recipe book approach. Most importantly, the experienced engineer and/or researcher need not be constrained by the functions and analysis in the method files provided. The operator may clone, modify and/or generate his/her own method file to suit their specific requirements. The Excel based data analysis offers the operator the flexibility to implement alternative analysis and customize reporting facilities. TestLab allows for real time graphing of results and configurable real time transducer levels display with unprecedented clarity of results and analytical power.

### MAIN FEATURES

- Open architecture software allows user to inspect calculations and results.
- Integrated data result post processing feature with MS Excel.
- Standard and user customizable test reporting.
- Real time graphing of results and configurable real time transducer.
- Flexible and user-friendly with unprecedented clarity of results and analytical power.
- Full access for advanced user to specify their own calculations, test results and charting.



## TESTLAB, A NEW APPROACH

TestLab is an open architecture user programmable software application. Our engineers have taken the time to review all the relevant international test standards and used TestLab **Test Designer** to program method files according to these standards. Basically, any of these tests can be designed, cloned and/or modified by the user within TestLab. The user is no longer restricted to the test applications provided at time of purchase the possibilities are only limited by the skill and imagination of the user.

### TESTLAB MANAGER

The Testlab materials testing software is a universal approach to materials testing and is designed to interface the CDAS – Control and Data Acquisition Systems - and the wide range of Pavetest machines. A Testlab Manager interface allows users to easily and efficiently locate the necessary method files to load and execute.

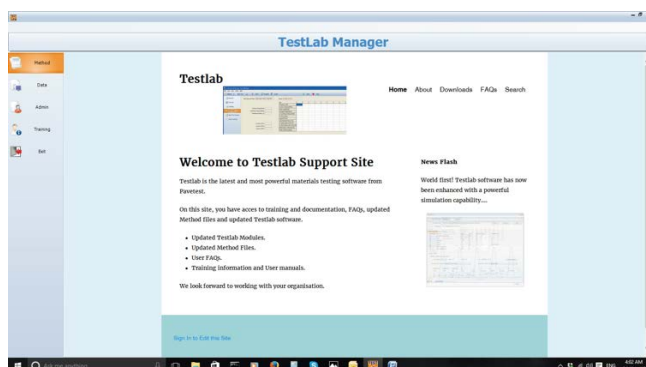

Testlab Manager

### TEST METHOD SELECTION

The operator can run pre-programmed Method files, in accordance to the requested Standards, or configure an application test and then save that configuration to a customised Method file. This includes the transducer and calibration allocations, control parameters, termination conditions and any other items, which allow users to enter data. Method files may easily be “cloned”, adapted and saved to be used at a later stage with pre-set preferences.

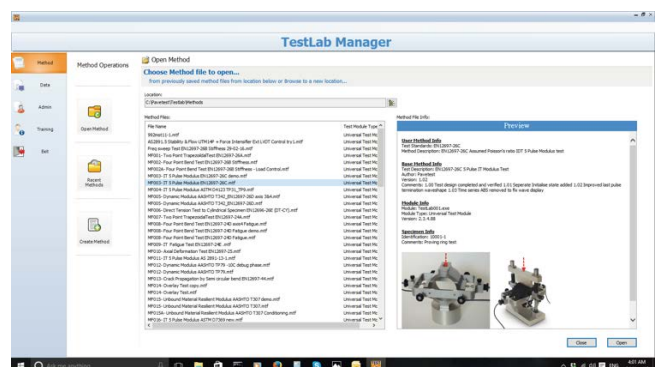

Selection of Method Files

# TESTLAB, USER FRIENDLY INTERFACE

## TEST WIZARD

The wizard section provides a prompted menu approach to running a test. The user is driven to enter information throughout a series of easy steps.

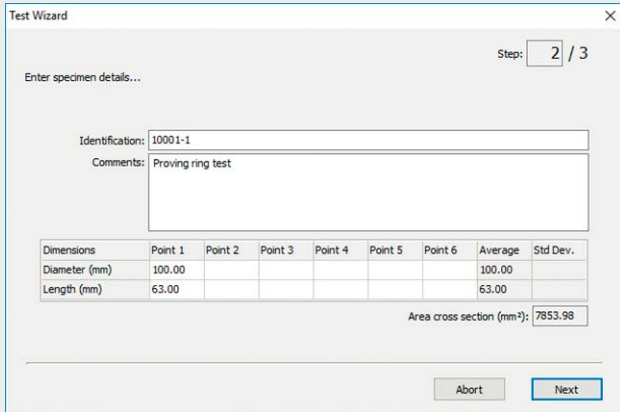

User guided Test wizard

## TESTLAB UNIVERSAL TEST

The Test Data section displays run-time information, such as the loading time, cycle count, transducer readings (force, displacement, pressure, temperature), stress calculations, strain calculations and other test specific properties.

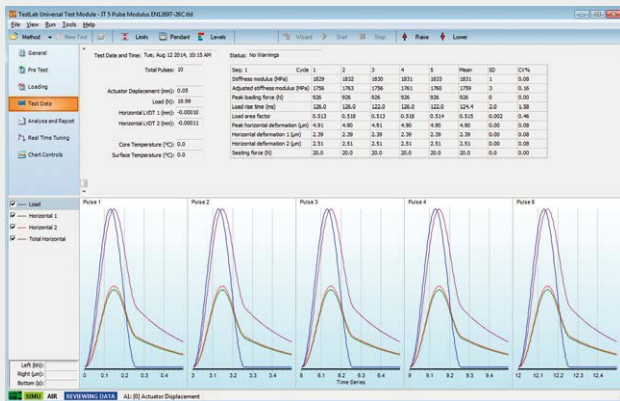

Test Data - EN12697-26C Indirect tension to cylindrical specimens

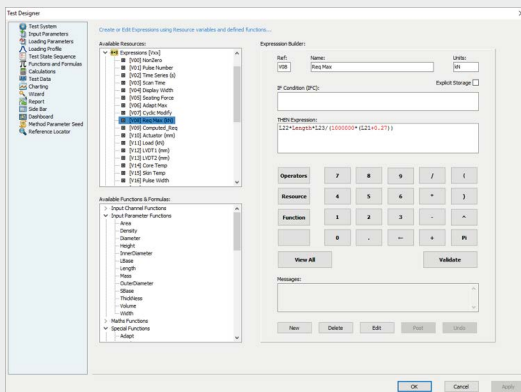

Test designer – Expressions and calculations editor

## REAL TIME DASHBOARD DISPLAY

For the more sophisticated tests, Pavetest provides the user with an alternative, simpler and more intuitive representation of the current status of both machine and test method. This dashboard display feature of TestLab shows real time transducer levels, computed data and charted data before, during and after the test has completed.

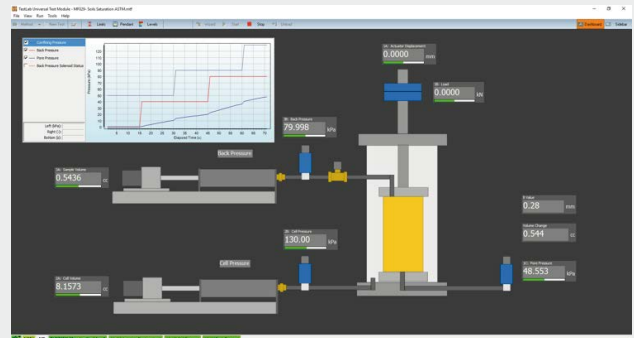

Typical dashboard screen

## POST PROCESSING

All Testlab Method file tests provide the facility to send the data directly to an Excel workbook including test input and results data. This facility provides a means of efficiently post processing raw data results and customizing reports from within Excel and optionally displaying summary result in TestLab.

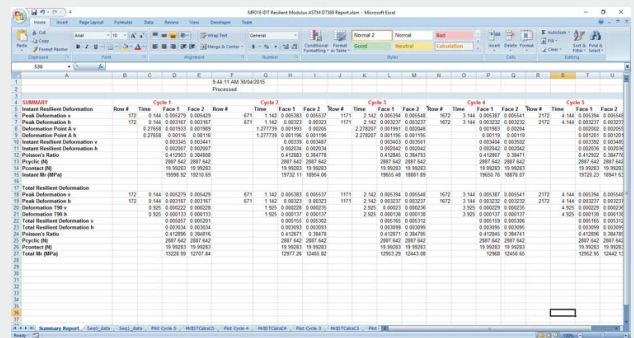

Post processing summary results

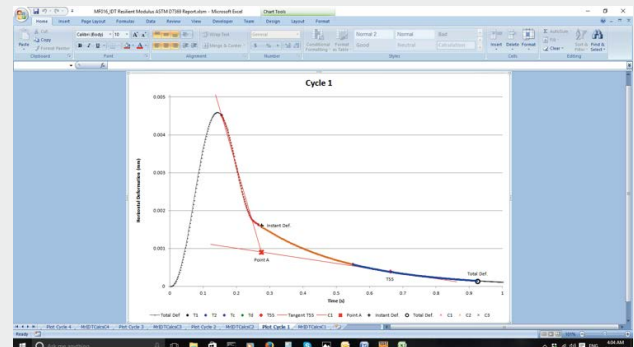

Excel post processing report

## UPGRADE YOUR UNIVERSAL TESTING MACHINE

It is a well-known fact that the controller and software is one of the most important aspect of any system and the main reason testing machines become outdated or obsolete. The original machine manufacturer often charge outrageous prices to upgrade the Control and Data Acquisition System and Software, knowing the customer has very little choice.

**Pavetest has now made it easier than ever to upgrade third party servo-hydraulic/pneumatic dynamic testing machines**, including but not limited to IPC Global, Controls, Cooper, Interlaken, MTS and Instron machines, to Pavetest's leading-edge Control and Data Acquisition System (CDAS) and world acclaimed TestLab software.

### MAIN FEATURES

- TestLab Software provides powerful and flexible solution.
- Comprehensive suite of pre-programmed Method Files.
- Ability to create your own Method Files.
- Adaptable for existing transducers.
- In-line signal conditioners.
- Interfaces to most third party Hydraulic Power Supplies.

### TESTLAB PC SOFTWARE

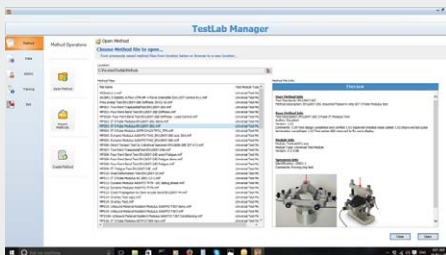

Selection of Method Files

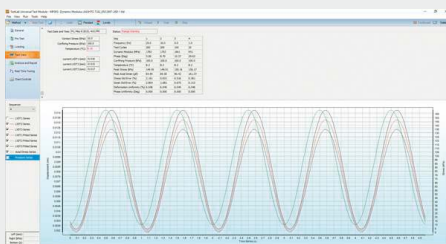

Test Methods



Typical dashboard screen



CDAS and HPS interface

### THIRD PARTY TESTING MACHINES

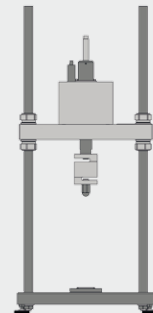

Servo Pneumatic test machine

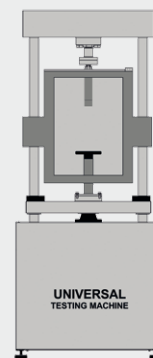

Servo Hydraulic test machine

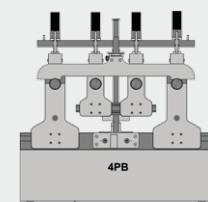

4 PT Beam test machine

## UPGRADE BENEFITS

This immediately offers the user access to a comprehensive suite of pre-programmed Method Files and/or the opportunity to create their own Method Files, to suit their individual needs. Pavetest can also provide interface cables and signal conditioners to adapt existing transducers to the Pavetest CDAS and offer additional transducers, already fitted with in-line signal conditioners to suit existing and new testing applications.

For servo-hydraulic systems; the Pavetest microprocessor controlled HPS interface unit allows Pavetest to interface our CDAS to most third party Hydraulic Power Supplies.

**Our 40 plus years' experience with servo-controlled systems and instrumentation places us in a strong position to restore your outdated system to current day standards.**



### MODULAR CONCEPT

Both the CDAS hardware and TestLab software use a modular approach allowing users to add new functionality to perform additional materials tests.



### AVAILABLE FOR ALL LANGUAGES

TestLab has a complete inbuilt language translation editor catering for translation of all languages.



### RENEWED PERFORMANCE

TestLab provides new and advanced acquisition and control capabilities for your old testing machine.



### COMPLETE INSTALLATION AND TRAINING

Pavetest can provide a complete onsite installation, commissioning and training for your upgrade package including supply of additional jigs, method files and transducers.

## ORDERING INFO

- B205** 8 channel CDAS  
or  
**B206** 16 channel CDAS  
**B205-01** HPS interface box  
**B205-02** 6 pin DIN (male) to 7 pin XLR (female) adaptors cable  
**B205-03** 6 pin DIN (female) to 7 pin XLR (male) adaptors cable



8 Channel Pavetest CDAS with Frame Control Interface.

## EXAMPLE OF SYSTEMS UPGRADED BY PAVETEST



Interlaken UTMs equipment upgraded by Pavetest, AAT, USA.



IPC Global UTM5P and UTM14P equipment upgraded by Pavetest, Fulton Hogan, Australia.

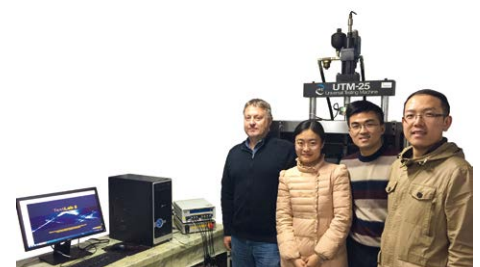

IPC Global UTM-25 equipment upgraded by Pavetest, SEU, China.



## 16 kN SERVO-PNEUMATIC DYNAMIC TESTING SYSTEM

TWO MODELS AVAILABLE:

### B220-01 KIT DTS-16 WITH MANUAL CROSSHEAD

### B220-02 KIT DTS-16 WITH MOTORIZED CROSSHEAD

The DTS-16 Dynamic Testing System is a servo-pneumatically controlled testing machine utilizing digital control of a pneumatic servo valve to provide accurate loading wave shapes up to 70 Hz. The DTS-16 can be operated in tension, compression dynamic loading and is suited to testing a diverse range of materials such as asphalt, soil, unbound granular materials, fibres and plastics.

The DTS-16 is underpinned by Pavetest's leading edge CDAS digital controller, TestLab software and a full complement of accessories, hardware and software in perfect unison.

#### MAIN FEATURES

- Compact, robust 2-Column load frame.
- Precision engineered.
- Optional Motorized crosshead positioning.
- Fully configurable to suit a large range of testing applications.
- Digital Servo-Pneumatic control.
- 4 axis control and 16 Channel Control and Data Acquisition System.

The machines includes:

**B220-11** 20 kN Load frame with manual crosshead,  
16 kN Servo-pneumatic actuator with its  
LVDT (30 mm stroke),  $\pm$  20 kN load cell

or

**B220-12** 20 kN Load frame with motorized crosshead,  
16 kN Servo-pneumatic actuator with its  
LVDT (30 mm stroke),  $\pm$  20 kN load cell

**B206** 16 Channel Control and Data Acquisition System  
(CDAS) & TestLab software

**B270-12** Air reservoir assembly with membrane dryer

It requires pressurized air, minimum 7 bar (not included).



#### **B220-02 KIT**

16 kN Servo-Pneumatic dynamic testing system (motorized crosshead) with **B221** Temperature controlled cabinet

Model	B220-01 KIT	B220-02 KIT
B220-11	▼	
B220-12		▼
B206	▼	▼
B270-12	▼	▼

## TECHNICAL SPECIFICATIONS

### Load frame

- Between Columns 345 mm
- Vertical Space 650 mm

### Servo actuator

- Capacity  $\pm 16$  kN
- Frequency up to 70 Hz
- Stroke 30 mm
- Air supply clean dry air
- Pressure 800-900 kPa
- Minimum rate up to 5 litres/sec

**Power Supply:** 90-264V 50-60Hz 1ph 240W (B220-11)  
 230V 50Hz 1ph 100W (B220-12)  
 230V 50Hz 1ph 1450W (B221)

**Dimensions:** 1262(h) x 400(d) x 470(w) mm B220-11 load frame  
 1262(h) x 400(d) x 510(w) mm B220-12 load frame  
 2170(h) x 840(d) x 760(w) mm load frame with  
 temperature controlled cabinet

**Weight:** 80 kg load frame B220-11 load frame  
 125 kg load frame B220-12 load frame  
 160 kg temperature controlled cabinet

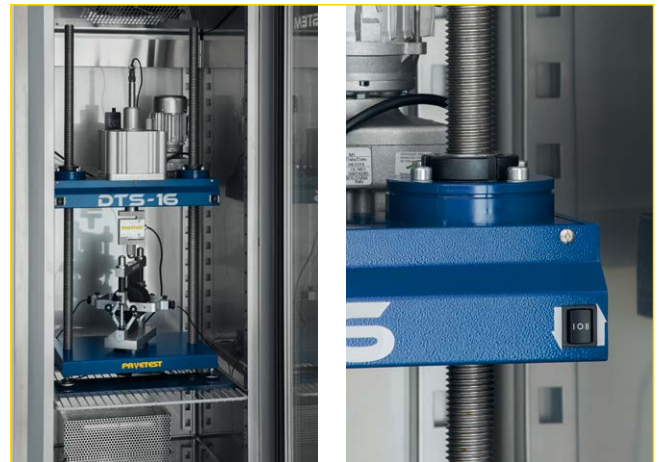

**B220-02 KIT**  
DTS-16 detail

**B220-12**  
20 kN Load frame with motorized  
crosshead

## TECHNICAL FEATURES

### ■ Optional motorized crosshead.

A motorized crosshead allows an easier test set-up in terms of accessories positioning without using any extension rods.

### ■ Latest technology.

The DTS-16 advantage revolves around the Control Data Acquisition System (CDAS) and TestLab Software.

### ■ Durable powder coated aluminium base plate with stainless steel work platen.

### ■ Air reservoir assembly with membrane dryer.

It allows a great insurance against damages to the servo-valve in case of moisture in the compressed air.

## RECOMMENDED ACCESSORIES

- B221** Temperature controlled cabinet: -20 °C to +70 °C  
to suit DTS-16 or 4PBA
- B250-07 KIT** Temperature measuring kit comprising:
- **B292-01** Temperature transducer (-80 °C to +80 °C)  
(2 pieces)
  - **B250-10** Dummy asphalt specimen
  - **B250-11** 100 mm "O" ring (3 pieces)
  - **B250-12** Thermal conducting grease (about 56 g)
- H009-01EN** PC complete with LCD monitor 22", keyboard,  
mouse, cables and installation of Testlab software

We can upgrade your existing UTM (also from other manufacturers)

For test configurations and related jigs, please consult p.17-28

**B270-12**  
Air reservoir assembly  
with membrane dryer



**B250-07 KIT**  
Temperature measuring kit

## B230 30 kN SERVO-HYDRAULIC DYNAMIC TESTING SYSTEM (DTS-30)

The DTS-30 Dynamic Testing System is a servo-hydraulic testing machine utilizing digital control of a high performance servo valve to provide accurate loading wave shapes up to 100 Hz. The DTS-30 can be operated in tension, compression dynamic loading and is suited to testing a diverse range of materials such as asphalt, soil, unbound granular materials, fibres and plastics. The DTS-30 is underpinned by Pavetest's leading edge CDAS digital controller, TestLab software and a full complement of accessories, hardware and software in perfect unison.

**The DTS-30 Dynamic Testing System is compact, fully integrated, user and environmentally friendly.**

### MAIN FEATURES

- Compact, robust load frame.
- Small footprint; 90 cm x 135 cm, including hydraulic power supply and climatic chamber.
- Reaction frame embedded in the test chamber.
- Portable temperature control unit.
- Fully configurable to suit a large range of testing applications.
- Digital Servo-Hydraulic control.
- Dynaflo™ HPS provides dynamic speed control of the pump motor ensuring quiet operation.
- 4 axis control and 16 channel data acquisition as standard.

The machine includes:

- Rigid two column load frame
- 30 kN Servo-hydraulic actuator (100 mm Stroke)
- 2.2 kW Hydraulic Power Supply
- 16 Channel Control and Data Acquisition System (CDAS) & TestLab software
- Load cell ( $\pm 30$  kN)
- 100 mm actuator LVDT



**B230 30 KN**  
 Servo-Hydraulic  
 Dynamic Testing System with B231 temperature controlled cabinet

## TECHNICAL SPECIFICATIONS

### Load frame

- Between Columns 600 mm
- Vertical Space 800 mm

### Servo actuator

- Capacity  $\pm 30$ kN static,  $\pm 25$ kN dynamic
- Frequency up to 100Hz
- Stroke 100 mm

### Hydraulic Power Supply

- Pressure up to 160 bar, user defined
- Flow rate up to 7.5 litres/min
- Dimensions: 650(h) x 550(d) x 450(w) mm
- Power Supply: 230V 50-60Hz 1ph 2.5kW

### Power Supply:

- 230V 50-60Hz 1ph 2.5kW (B230)
- 230V 50Hz 1ph 1.3kW (B231)
- 230V 50Hz 1ph 3.1kW (B232)

### Dimensions:

- 2100(h) x 1220(d) x 800(w) mm load frame
- 2100(h) x 1800(d) x 800(w) mm with temperature controlled cabinet

### Weight:

- 430 kg approx. load frame
- 650 kg approx. load frame with temperature controlled cabinet and oil-filled HPS

## TECHNICAL FEATURES

- The DTS-30 fatigue rated, servo-hydraulic actuator utilizes metal labyrinth bearings and seals.**  
The labyrinth bearings and seals are designed to reduce friction and maintain low operating temperatures. The bearings experience little-to-no wear, operate at high speeds and offer a long service life.
- A bottom loading machine.** Before this current crop of universal testing machines, many dynamic testing machines were bottom loading. More recently, the Asphalt Mixture Performance Tester (AMPT) changed the mindset of the testing community by highlighting the benefits of a bottom loading machine.
- Portable temperature control unit.** The temperature control unit attaches to the test chamber using a magnetic seal and can be wheeled away when not required or for servicing. It can be removed without dismantling the machine or disrupting the testing program.

## NEEDED ACCESSORIES

- B231** Temperature controlled cabinet:  
-20 °C to +80 °C to suit DTS-30 or DTS-130  
or
- B232** Temperature controlled cabinet:  
-40 °C to +80 °C to suit DTS-30 or DTS-130
- B233** Temperature controlled cabinet:  
-50 °C to +100 °C to suit DTS-30 or DTS-130

These temperature controlled cabinets may be supplied with humidity control, if required.

## RECOMMENDED ACCESSORIES

- H009-01EN** PC complete with LCD monitor 22", keyboard, mouse, cables and installation of Testlab software
- B250-07 KIT** Temperature measuring kit comprising:
- B292-01** Temperature transducer (-80 °C to +80 °C) (2 pieces)
  - B250-10** Dummy asphalt specimen
  - B250-11** 100 mm O ring (3 pieces)
  - B250-12** Thermal conducting grease (about 56 g)

We can upgrade your existing UTM (also from other manufacturers)

For test configurations and related jigs, please consult p. 17-28

**Can't see the Control and Data Acquisition System (CDAS)?** That's because **it's housed neatly, in the cabinet in front of the machine.**

You won't see a tangle of cables either; they enter the cabinet through the floor of the test chamber or through the back of the cabinet and connect to the CDAS.

The door of the cabinet can be held ajar to allow transducers to be re-allocated or opened completely for servicing. Unused transducers can also be stored out of harm's way.

Moreover, the DTS-30 reaction frame is symmetrical; **the servo-hydraulic actuator and reaction shaft can be interchanged to make the DTS-30 top loading.**



**B206** 16 Channel CDAS

## WHAT MAKES IT DIFFERENT MAKES IT BETTER!

The DTS-30 is Universal Testing Machine (UTM), but not as most people know it. **It does not conform to the “me too” attitude of most UTM manufacturers.** The innovations featured on the DTS-30 are built on many years of experience, developing, studying and using various universal testing machines from a number of manufacturers.

The first thing you will notice about the DTS-30 is the absence of a reaction frame. **The reaction frame** most certainly exists, but it's **embedded in the test chamber.**

Since it is mandatory to control the test temperature of most pavement materials, e.g. asphalt, **the test chamber is insulated and forms part of the temperature controlled cabinet.**

Most UTM manufacturers opt for an elaborate (and expensive) moveable crosshead, only to find that its range (and usefulness) is limited by the climatic chamber. The DTS-30 has a remotely positioned reaction shaft that adjusts the work space. However, you won't need to adjust it often because the **servo-hydraulic actuator has 100 mm of stroke.**



**B230 DTS-30 Dynamic Testing System, detail**



Portable temperature control unit



### DYNAFLO™ HPS

The speed of the pump motor is controlled using a **variable-frequency drive (VFD), or inverter.** This enables the motor to be slowed down, or turned off, when the oil flow from the pump exceeds the flow required by the actuator at any given time.



### QUIET

The servo-hydraulic testing machine is almost **silent during the majority of test applications.** The equipped Dynaflo-Hps not only reduces noise and heat generation but also offers cost savings, by reducing power consumption.



### DESIGN SOLUTION

A neat, compact and integrated solution where the **reaction frame is embedded** in the test chamber, for a very sleek appearance. Moreover, short hydraulic hoses connect the actuator to the HPS that's tucked neatly away behind the machine, under the test chamber.



### EASY MAINTENANCE

The **portable temperature control unit** makes servicing, replacing or upgrading the control unit virtually effortless.



### DIRECT COMMUNICATION

The test temperature and/or ramp rate may be set and monitored through TestLab software, via the virtual pendant.

## B240 VFD 130 kN SERVO-HYDRAULIC DYNAMIC TESTING SYSTEM (DTS-130)

The DTS-130 Dynamic Testing System is a servo-hydraulic testing machine utilizing digital control of a high performance servo valve to provide accurate loading wave shapes up to 100 Hz. The DTS-130 is Pavetest's highest capacity Dynamic Testing System and completes the range of standard universal testing machines. The system can be operated in tension, compression dynamic loading and is suited to testing a diverse range of engineering materials and/or large asphalt specimens at very cold temperatures.

The DTS-130 is underpinned by Pavetest's leading edge CDAS digital controller, TestLab software and a full complement of accessories, hardware and software in perfect unison.

### MAIN FEATURES

- Robust two column load frame.
- Double acting servo hydraulic, equal area type with low friction, long life bearings and seals.
- Portable temperature control unit.
- Fully configurable to suit a large range of testing applications.
- Digital Servo-Hydraulic control.
- Dynaflo™ HPS variable frequency drive (VFD) provides dynamic speed control of the pump motor ensuring quiet operation.
- 4 axis control and 16 channel data acquisition as standard.

The machine includes:

- Rigid two column load frame
- 130 kN Servo-hydraulic actuator (100 mm Stroke)
- 10 kW Hydraulic Power Supply
- 16 Channel Control and Data Acquisition System (CDAS) & TestLab software
- Load cell ( $\pm 130$  kN)
- 100 mm actuator LVDT



### B240

130 kN Servo-Hydraulic Dynamic Testing System  
with **B231** temperature controlled cabinet

## TECHNICAL SPECIFICATIONS

### Load frame:

- Horizontal Space: 60 cm
- Vertical Space: 100 cm

### Servo actuator:

- Capacity:  $\pm 130\text{kN}$  Static  $\pm 100\text{kN}$  Dynamic
- Frequency: Up to 100Hz
- Stroke: 100 mm

### Hydraulic Power Supply:

- Pressure: Up to 210 bar, user defined
- Flow rate: 20 litres/min
- Dimensions: 1150 (h) x 600 (d) x 1100 (w) mm
- Power supply: 380V 50Hz or 208V 60Hz 12kW 3ph

### Power Supply:

- 380V 50Hz 3ph + neutral 12kW or
- 208V 60Hz 3ph + 12kW (B240 VFD)
- 230V 50Hz 1ph 1.3kW (B231)
- 230V 50Hz 1ph 3.1kW (B232)

### Dimensions:

- 3005 (h) x 1070 (d) x 1090 (w) mm load frame
- 3005 (h) x 1630 (d) x 1090 (w) mm with temperature controlled cabinet

### Weight:

- 680 kg approx. load frame
- 1360 kg approx. load frame with temperature controlled cabinet and oil-filled HPS



**B240** 130 kN Servo-Hydraulic Dynamic Testing System with **H009-01EN** complete PC, **B231** Temperature controlled cabinet, **B240-03** Exchanger oil/water, HPS (hydraulic power supply)

ACCESSORIES		B240-02 Exchanger oil/air	B240-03 Exchanger oil/water *
<b>B240-04</b>	Chiller for water refrigeration (recommended)		▼
<b>B240-05</b> or <b>B240-06</b>	Set of hoses to connect frame - pumping unit Lg. 3 m (needed) Set of hoses to connect frame - pumping unit Lg. 8 m (needed)	▼ ▼	▼ ▼
<b>B240-07</b> or <b>B240-08</b>	Set of hoses to connect pumping unit - Exchanger oil/air Lg. 5 m (needed) Set of hoses to connect pumping unit - Exchanger oil/air Lg. 10 m (needed)	▼ ▼	
<b>B240-09</b> or <b>B240-10</b>	Set of hoses to connect Exchanger oil/water - Chiller Lg. 5 m (recommended) Set of hoses to connect Exchanger oil/water - Chiller Lg. 10 m (recommended)		▼ ▼

\* (complete with set of hoses to connect pumping unit Exchanger oil/water)

The **Hydraulic Power Supply (HPS)** utilizes a variable flow pump with a working pressure up to 210 Bar. The customer can choose either water (heat exchanger) or air (Electric fan) oil cooling. Features include; low oil, over temperature and dirty filter indication, remote starting and user selectable working pressure (via TestLab).

**B231** Temperature controlled cabinet:  
-20 °C to +80 °C to suit DTS-30 or DTS-130

or

**B232** Temperature controlled cabinet:  
-40 °C to +80 °C to suit DTS-30 or DTS-130

**B233** Temperature controlled cabinet:  
-50 °C to +100 °C to suit DTS-30 or DTS-130

These temperature controlled cabinets may be supplied with humidity control, if required.

We can upgrade your existing UTM (also from other manufacturers)

## RECOMMENDED ACCESSORIES

- H009-01EN** PC complete with LCD monitor 22", keyboard, mouse, cables and installation of Testlab software
- B250-07 KIT** Temperature measuring kit (refer to p. 9)

For test configurations and related jigs, please consult p. 17-28

## TWO PIECE TEMPERATURE CONTROLLED CABINET

Pavetest offers a range of temperature controlled cabinet to complement our **DTS-30** and **DTS-130** servo-hydraulic Dynamic Testing Systems (DTS). **Pavetest is the first manufacturer to adopt a two piece temperature controlled cabinet**; comprising an insulate cabinet and a temperature control unit. The cabinet is permanently mounted on the dynamic testing machines, whilst the temperature control unit can be wheeled away when not required, leaving the back of the chamber open to accommodate longer jigs/specimens that do not require a controlled environment. The temperature control unit attaches to the cabinet using a magnetic seal. This isolates the cabinet from mechanical vibrations caused by the refrigeration unit and circulation fans whilst maintaining an air tight seal between the inside and outside of the chamber. This concept also makes servicing, replacing or upgrading the temperature control unit virtually effortless, because it can be removed with-out dismantling the machine or disrupting the testing program.

### MAIN FEATURES

- Two piece concept makes servicing, replacing or upgrading the temperature control unit effortless.
- Flexible temperature sensor ensures the temperature near the specimen is accurately controlled.
- Operator can monitor, set, adjust or “Auto tune” the temperature controller via the PC.
- Heavy duty stainless steel construction.
- Powerful re-circulation fans ensure even temperature through-out the chamber.
- Triple Glazed, Argon filled, Lo E glass door with built in heater.



Two piece temperature controlled cabinet



**ORDERING INFORMATION**

**B231** Temperature controlled cabinet:  
 -20 °C to +80 °C to suit DTS-30 or DTS-130

or

**B232** Temperature controlled cabinet:  
 -40 °C to +80 °C to suit DTS-30 or DTS-130

**B233** Temperature controlled cabinet:  
 -50 °C to +100 °C to suit DTS-30 or DTS-130,  
 supplied with humidity control, if required

Other temperature ranges and operating voltage/frequency available on request.

The temperature controller can be programmed using the virtual pendant within TestLab software, via a serial link between the temperature controller and the Control and Data Acquisition System (CDAS). This allows the operator to monitor, set or adjust a constant temperature or ramp without touching the temperature controller, including invoking the "Auto tune" function. This feature is particularly useful for the TSRST test, where programming the temperature controller is not a simple task.

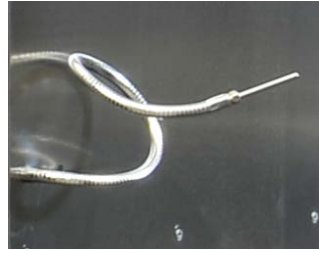

Temperature controller sensor

Pavetest has introduced some additional features to improve the functionality of our temperature controlled cabinets. **The sensor for the temperature controller is mounted on a flexible arm** which allows the operator to locate the sensor in the vicinity of the test specimen; providing accurate temperature control where it's needed most; right near the specimen.

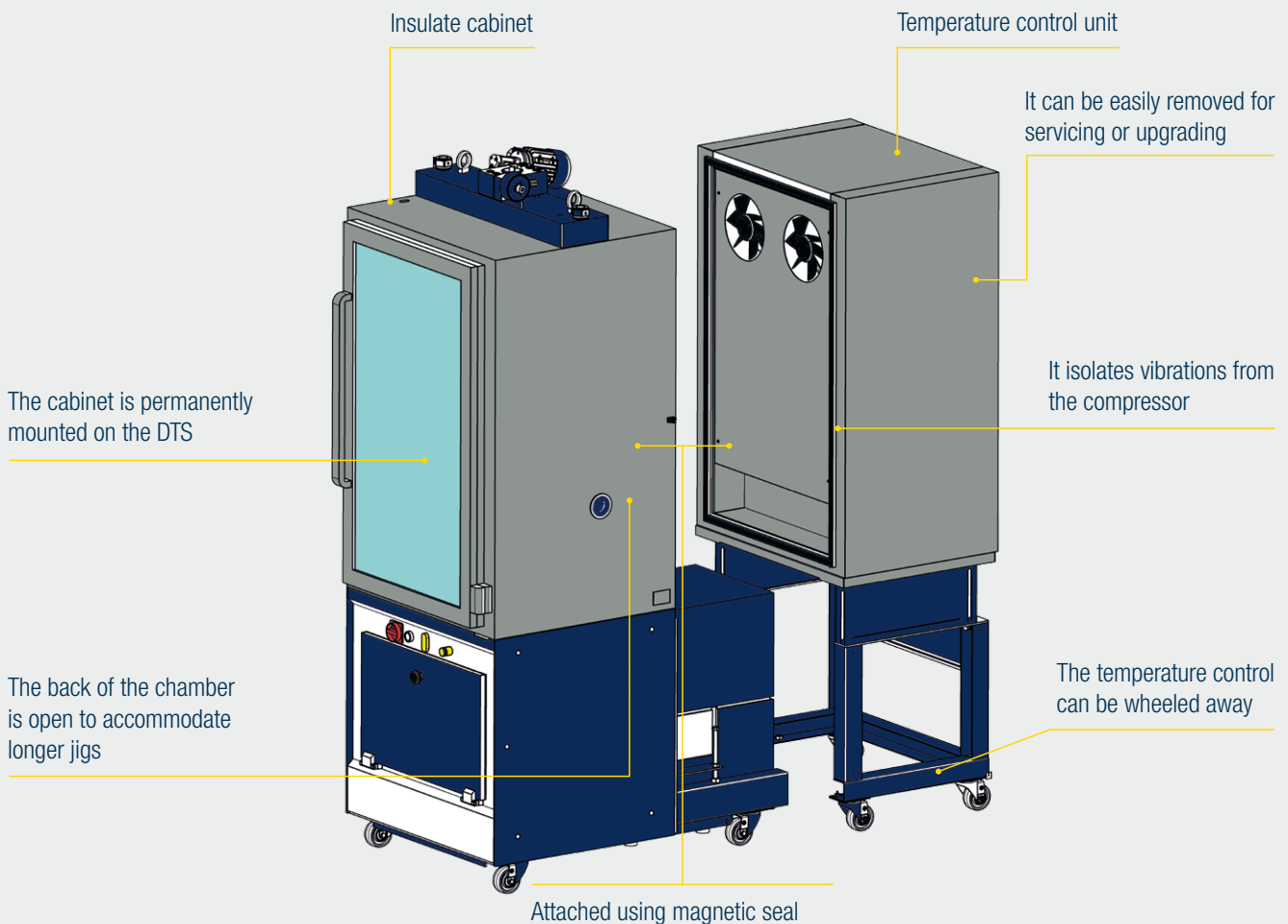

Cabinet switches and temperature controllers

**A TWO PIECE TEMPERATURE CONTROLLED CABINET**

## DYNAMIC TEST CONFIGURATIONS

The following pages describe specific testing kits to perform dynamic tests on asphalt mixture and other pavement materials, by using our range of DTS's Dynamic Testing Systems: DTS-16, DTS-30 and DTS-130. These kits have to be integrated with various additional items, in order to obtain a complete assembly.



## B250 KIT Indirect Tensile Modulus - IDTM

STANDARDS: AASHTO TP31 Resilient modulus of bituminous mixtures by indirect tension  
 ASTM D4123 Indirect Tension Test for Resilient Modulus of Bituminous Mixtures  
 AS/NZS 2891.13.1 Resilient modulus of asphalt - Indirect tensile method  
 EN 12697-26 Annex C - Indirect tension to cylindrical specimens (IT-CY)

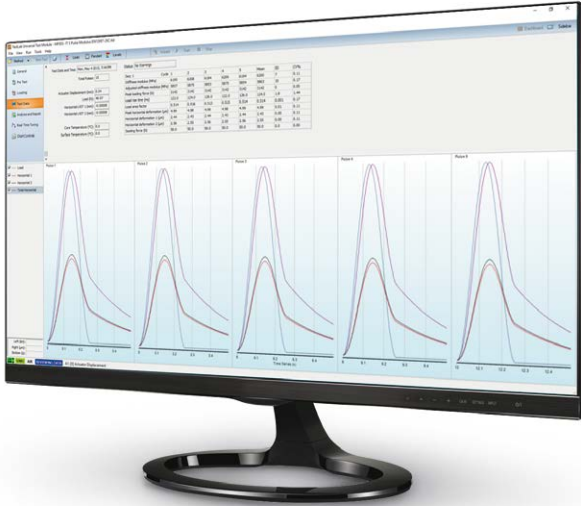

### TEST FRAMES

Manual DTS-16 | Motorized DTS-16 (B221)  
 DTS-30 | DTS-130 (B231 or B232)

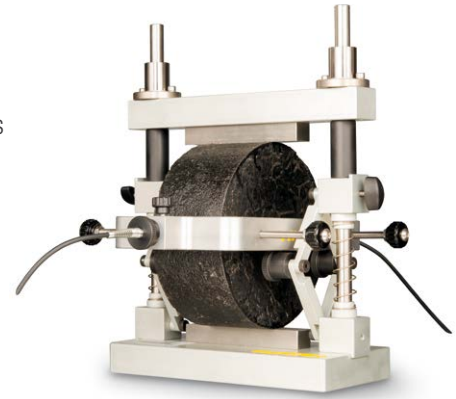

### B250 KIT Indirect Tensile Modulus

Comprises:

- B250-01** Basic IDT Jig
- B250-08** Yoke
- B250-09** Assembly for B250 KIT
- B290-01** LVDT (0.2 mm) (2 pieces)

### ACCESSORIES

- B250-03** Asphalt proving ring
- B250-04** 100 mm diameter PVC specimen
- B250-05** 150 mm diameter PVC specimen
- B250-06 KIT** Torque screwdriver (B250-13) with hexagonal head 4 mm (B250-14)

## B251 KIT Indirect Tensile Fatigue - IDTF

STANDARD: EN 12697-24 Annex E – Indirect tensile test on cylindrical shaped specimens

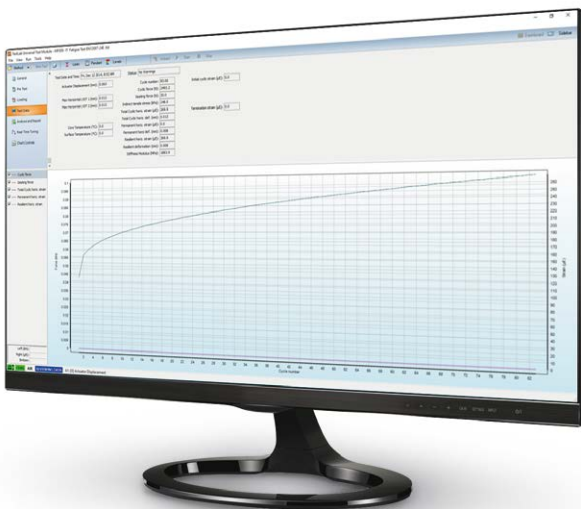

### TEST FRAMES

Manual DTS-16 | Motorized DTS-16 (B221)  
 DTS-30 | DTS-130 (B231 or B232)



### B251 KIT Indirect Tensile Fatigue

Comprises:

- B250-01** Basic IDT Jig
- B290-03** LVDT, double ball ended (3.75 mm) (2 pieces)
- B251-01** LVDT mounting strip gluing jig

### ACCESSORIES

- B251-51** Pair of LVDT mounting strip to suit 100 mm specimen (**needed** accessory)

And/or

- B251-52** Pair of LVDT mounting strip to suit 150 mm specimen (**needed** accessory)
- B201-52** 5 Minute, two part epoxy 24 ml

## B260 KIT Uniaxial cyclic compression - UCC

STANDARD: EN 12697-25 Cyclic compression. Test Method A - Uniaxial cyclic compression test with confinement  
TP Asphalt-StB 25A1: Dynamic punching test on mastic asphalt  
TP Asphalt-StB 25A2: Dynamic punching test on rolled asphalt

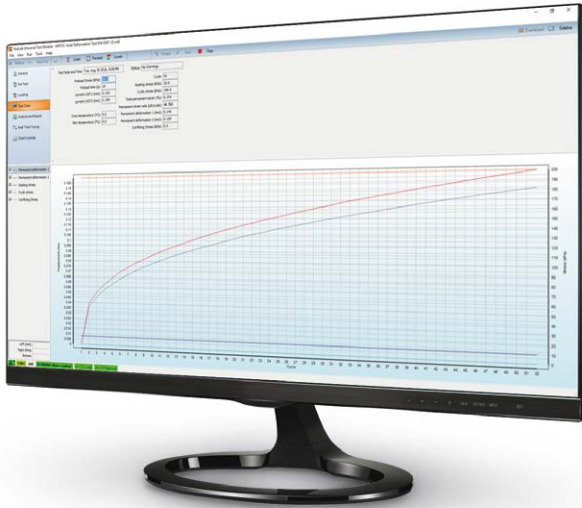

### B260 KIT Uniaxial cyclic compression

Comprises:

- B260-01** Base assembly
- B260-02** Chamfered top platen
- B290-02** LVDT (10 mm) (2 pieces)

### ACCESSORY

- B260-05** Upper loading platen in accordance with method A2 EN 12697-25
- B260-06** 56.4 mm top loading platen for TP Asphalt-STB Part 25A1
- B260-07** 80 mm top loading platen for TP Asphalt-STB Part 25A2

### TEST FRAMES

Manual DTS-16 | Motorized DTS-16 (B221)  
DTS-30 | DTS-130 (B231 or B232)

## B260-10 PULL OFF TENSION JIG

STANDARD: TP Asphalt-StB – Part 81, Adhesive pull strength of thin asphalt layers



**B260-10** Pull off tension jig

### TEST FRAMES

DTS-30 (B231 or B232)

### ACCESSORY

- B261-01** DTS-30 Tension base (needed)

## B253 KIT Indirect Tensile modulus, creep compliance and strength using on-specimen transducers - IDTOS

STANDARDS: ASTM D7369 Resilient Modulus of Bituminous Mixtures by Indirect Tension Test  
 AASHTO T322 Creep Compliance and Strength of Hot-Mix Asphalt (HMA)  
 Using the Indirect Tensile Test Device

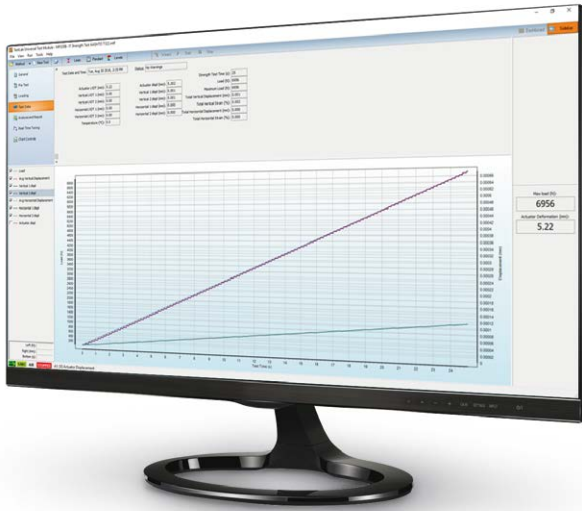

**B253 KIT** Indirect Tensile modulus, creep compliance and strength  
 using on-specimen transducers

Comprises:

**B250-01** Basic IDT Jig

**B253-01** AASHTO T322 LVDT mounting Jig

**B290-04** Miniature LVDT (1 mm) (4 pieces)

**B253-02** AASHTO T322 gauge point template (100 mm specimen)

**B253-03** AASHTO T322 gauge point template (150 mm specimen)

### TEST FRAMES

Manual DTS-16 | Motorized DTS-16 (B221)  
 DTS-30 | DTS-130 (B231 or B232)

### ACCESSORIES

**B253-53** Gauge point (24 **needed** pieces)

**B201-52** 5 Minute, two part epoxy 24 ml

## B212 Four Point Bending for use with Pavetest B230 - 4PB

STANDARDS: AASHTO T 321 Fatigue Life of Compacted Hot-Mix Asphalt (HMA) Subjected to Repeated Flexural Bending  
 ASTM D7460 Fatigue Failure of Compacted Asphalt Concrete Subjected to Repeated Flexural Bending  
 AG:PT/T233 & ASTM O3 Fatigue life of compacted bituminous mixes subject to repeated flexural bending  
 EN 12697-24 Annex D - Four point bending test on prismatic shaped specimens  
 EN 12697-26 Annex B - Four point bending test on prismatic specimens (4PB-PR)

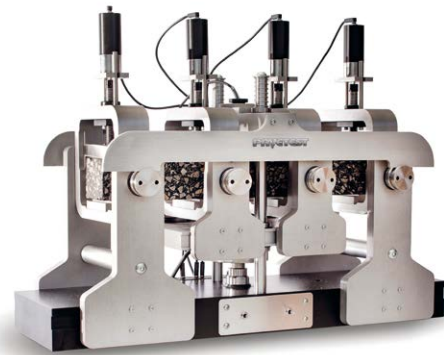
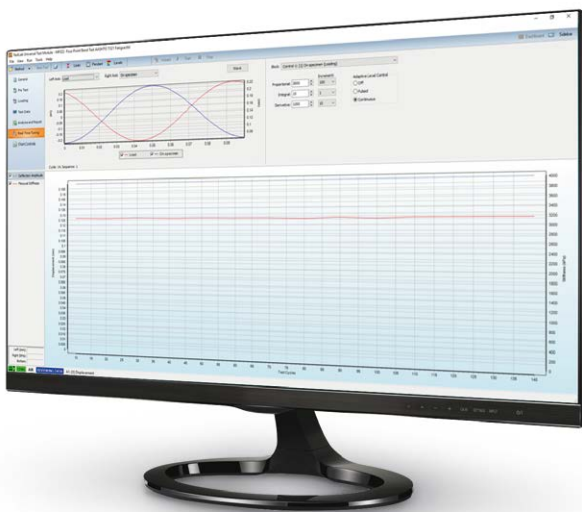

### TEST FRAMES

DTS-30 (B231 or B232)

### ACCESSORIES

**B210-02** 4PB PVC Beam

**B210-03** 4PB Reference beam

## B280 KIT TWO POINT BENDING (2PB) TO SUIT B230 - 2PB

STANDARDS: EN 12697-24 Annex A - Two-point bending test on trapezoidal shaped specimens (2PB-TR)  
EN 12697-26 Annex A - Two point bending test on trapezoidal specimens (2PB-TR)

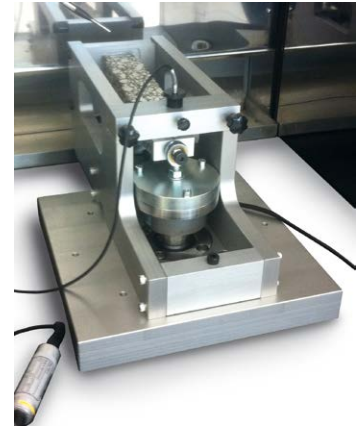
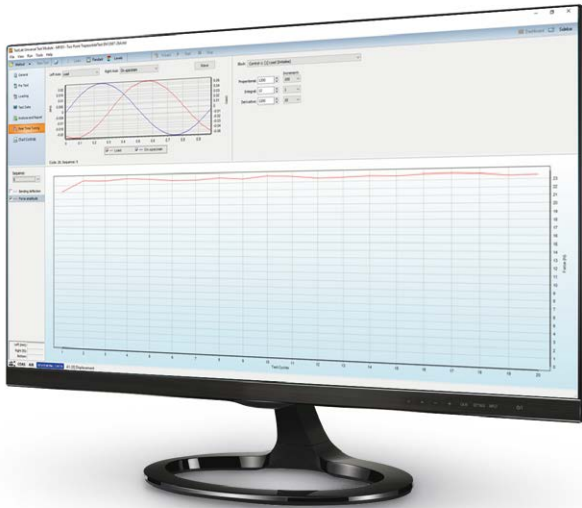

**B280 KIT** Two Point Bending (2PB) to suit B230.  
Comprises:

- B280-01** 2PB Jig
- B280-51** 2PB Mounting plate (25 mm apex)
- B280-52** 2PB Mounting plate (50 mm apex)
- B280-53** 2PB Mounting plate (base)

### TEST FRAMES

DTS-30 (B231 or B232)

### ACCESSORIES

- B290-05** LVDT (2 mm) (**needed** accessory)
- B280-02** Two point Bending (2PB) gluing jig (**needed** accessory)
- B201-52** 5 Minute, two part epoxy 24 ml

## B261 KIT Permanent deformation - PD

STANDARD: AS/NZS 2891.12.1 Determination of the permanent compressive strain characteristics of asphalt - Dynamic creep test  
TP Asphalt-StB – Part 25B Uniaxial pressure-fatigue testing. Determination of deformation behavior of roller asphalt during heat

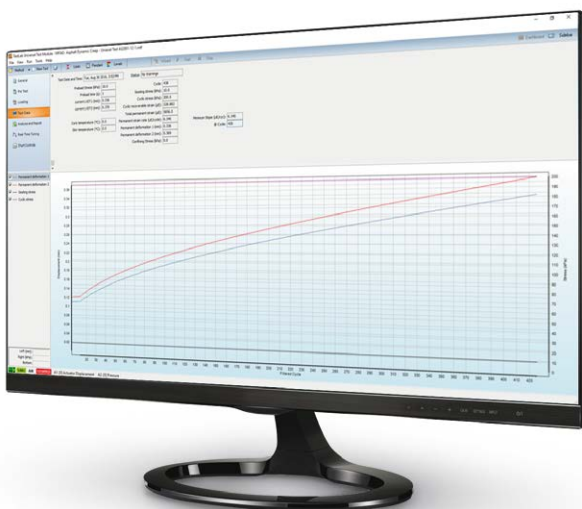

**B261 KIT** Permanent deformation  
Comprises:

- B260-01** Base assembly
- B260-03** 100 mm top platen
- B290-02** LVDT (10 mm) (2 pieces)

### TEST FRAMES

Manual DTS-16 | Motorized DTS-16 (B221)  
DTS-30 | DTS-130 (B231 or B232)

### ACCESSORY

- B260-04** 150 mm top platen

## B255 KIT Dynamic modulus - E\*

STANDARD: AASHTO T342 Determining Dynamic Modulus of Hot Mix Asphalt (HMA)

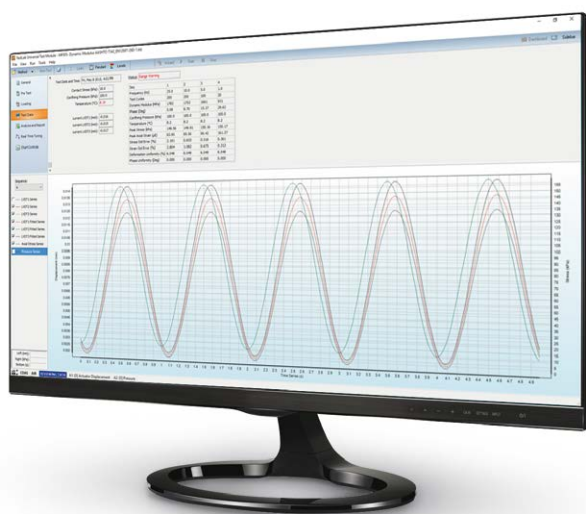

### B255 KIT Dynamic modulus

Comprises:

- B200-02** 105 mm bottom loading platen
- B200-03** 105 mm top loading platen
- B253-04** AASHTO T342 LVDT mounting jig (3 pieces)
- B290-06** LVDT (1 mm) (3 pieces)
- B253-05** Screwdriver hex bit with spherical head size 2 mm

### TEST FRAMES

DTS-30 | DTS-130 (B231 or B232)

### ACCESSORIES

- B202** Gauge Point Fixing Jig
- B203** Dynamic Verification Device
- B253-53** AASHTO T342 gauge point (24 **needed** pieces)
- B201-52** 5 Minute, two part epoxy 24 ml

### DYNAMIC MODULUS ON SMALL SPECIMENS | DTS-30/130

To test 38 mm (diameter) x 110 mm (h) specimens with DTS-30/130, the following items are required

- B200-05** Bottom loading platen for 38 x 110 mm (Ø x h) specimen
- B200-06** Top loading platen for 38 x 110 mm (Ø x h) specimen
- B253-04** AASHTO T342 LVDT mounting jig (3 pieces)
- B290-06** LVDT (1 mm) (3 pieces)
- B253-53** AASHTO T342 gauge point (24 needed pieces)
- B253-05** Screwdriver hex bit with spherical head size 2 mm
- B202** Gauge Point Fixing Jig
- B202-02** Spacer for 110 mm specimen height to be used with gauge point fixing jig B202
- B202-03** 38 mm and 50 mm diameter specimen - extension for gauge point fixing jig plungers B202
- B203** Dynamic Verification Device (optional)
- B201-52** 5 Minute, two part epoxy 24 ml (optional)

To test 50 mm (diameter) x 135 mm (h) specimens with DTS-30/130, the following items are required:

- B200-07** Bottom loading platen for 50 x 135 mm (Ø x h) specimen
- B200-08** Top loading platen for 50 x 135 mm (Ø x h) specimen
- B253-04** AASHTO T342 LVDT mounting jig (3 pieces)
- B290-06** LVDT (1 mm) (3 pieces)
- B253-53** AASHTO T342 gauge point (24 needed pieces)
- B253-05** Screwdriver hex bit with spherical head size 2 mm
- B202** Gauge Point Fixing Jig
- B202-01** Spacer for 135 mm specimen height to be used with gauge point fixing jig B202
- B202-03** 38 mm and 50 mm diameter specimen - extension for gauge point fixing jig plungers B202
- B203** Dynamic Verification Device (optional)
- B201-52** 5 Minute, two part epoxy 24 ml (optional)

## B271 KIT Cyclic triaxial compression - CCT

STANDARD: EN 12697-25 Cyclic compression. Test Method B - Triaxial cyclic compression test

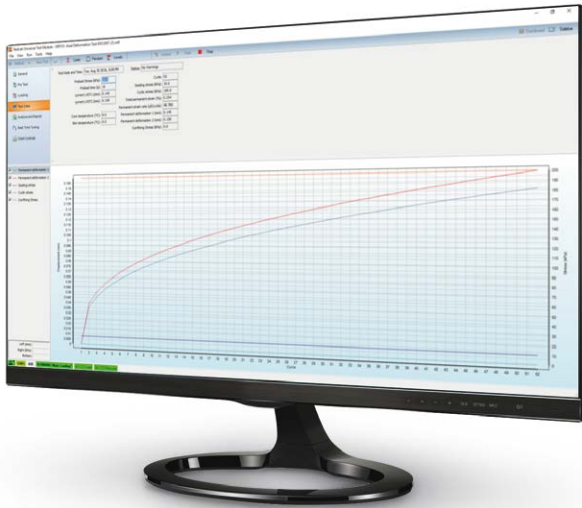

### TEST FRAMES

Manual DTS-16 | Motorized DTS-16 (B221)  
DTS-30 | DTS-130 (B231 or B232)

**B271 KIT** Cyclic triaxial compression  
Comprises:

- B270-01** Triaxial cell, suitable for  $\varnothing$  100 mm, up to 200 mm height specimens
- B270-02** Triaxial cell external LVDT mounting jig
- B293-01** Pressure transducer ( $\pm$  300 kPa)
- B270-06** 110 mm diameter top loading platen for EN 12697-25B
- B270-15** 110 mm diameter base pedestal for 100 mm height specimen



### ACCESSORIES

- B290-02** Displacement transducer (10 mm) (2 pieces **needed**)
  - B270-04** Air reservoir assembly confining pressure upgrade kit (**needed** accessory for DTS-16)
- or
- B270-03** Air reservoir assembly with confining pressure control (**needed** accessory for DTS-30/130)
  - B270-17**  $\varnothing$  200 mm base plate (**needed** accessory for DTS-30)
  - B270-18** Membrane stretcher for asphalt specimen  $\varnothing$  100 mm
  - B201-53**  $\varnothing$  100 mm rubber membrane 0.3 mm thickness (pack of 10)
  - S311-03**  $\varnothing$  100 mm sealing ring (10 pieces)
  - S316-03**  $\varnothing$  100 mm porous disc (2 pieces) needed for AASHTO T307  
Requires pressurized air, minimum 7 bar (not included)

## B272 KIT Triaxial resilient modulus - TRM

STANDARD: AASHTO T307 Determining the resilient modulus of soils and aggregate materials

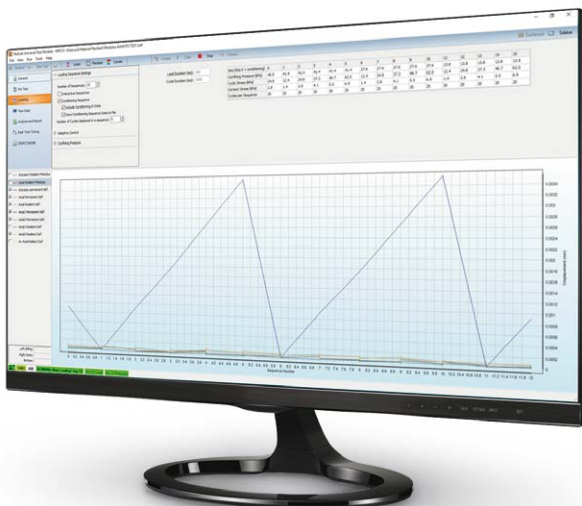

### TEST FRAMES

Manual DTS-16 | Motorized DTS-16 (B221)  
DTS-30 | DTS-130 (B231 or B232)

**B272 KIT** Triaxial resilient modulus  
Comprises:

- B270-01** Triaxial cell, suit able for  $\varnothing$  100 mm, up to 200 mm height specimens
- B270-02** Triaxial cell external LVDT mounting jig
- B293-02** Pressure transducer ( $\pm$  600 kPa)
- S315-07** 100 mm diameter bottom platen
- S314-03** 100 mm diameter top platen



### ACCESSORIES

Same accessories of B271 KIT



## B274-KIT Triaxial testing kit

STANDARDS: AASHTO TP 79-09 Standard Method Test for Determining the Dynamic Modulus and Flow Number for Hot Mix Asphalt (HMA)  
 AASHTO T378 Standard Method of Test for Determining the Dynamic Modulus and Flow Number for Asphalt Mixtures

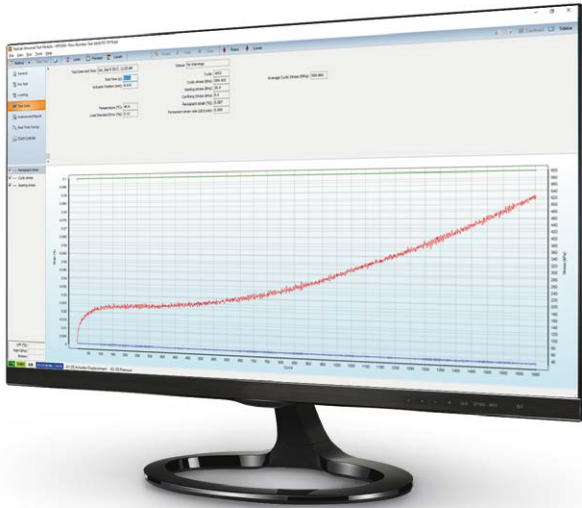

### TEST FRAMES

Manual DTS-16 | Motorized DTS-16 (B221)  
 DTS-30 | DTS-130 (B231 or B232)

**B274 KIT** Triaxial testing Kit  
 Comprises:

- B270-01** Triaxial cell, suitable for  $\varnothing$  100 mm x up to 200 mm tall
- B293-01** Pressure transducer ( $\pm$  300kpa)
- B200-03** 105 mm top loading platen
- B270-16**  $\varnothing$  105 mm base pedestal for 150 mm height specimen



### ACCESSORIES

- B200-01** AMPT LVDT 2.00 mm (3 needed)
  - B270-04** Air reservoir assembly confining pressure upgrade jig (needed for DTS-16)
- or
- B270-03** Air reservoir assembly with confining pressure control (needed for DTS-30/130)
  - B253-53** AASHTO T342 gauge point (24 pieces needed)
  - B201-52** 5 minute, two part epoxy 24 ml
  - S311-03** Sealing ring  $\varnothing$  100 mm
  - B201-53** 100 mm rubber membrane 0.3 mm thickness (pack of 10)
  - B202** Gauge point fixing jig
  - B203** AMPT dynamic verification device
  - B200-10** Latex membrane material cut in  $\varnothing$  100 mm discs (needed for AASHTO T378)

Requires pressurized air, minimum 7 bar (not included)

## B254 KIT Semi-Circular Bending - SCB

STANDARD: EN 12697-44 Tensile Strength and Fracture Toughness-Crack Propagation

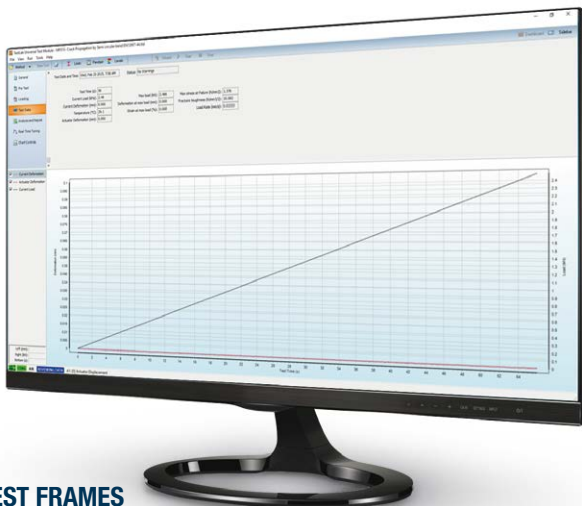

### TEST FRAMES

Manual DTS-16 | Motorized DTS-16 (B221)  
 DTS-30 | DTS-130 (B231 or B232)

**B254 KIT** EN SCB testing kit  
 Comprises:

- B254-01** SCB jig
- B254-51** Pair of SCB wear plates



### ACCESSORIES

- B250-01** Basic Indirect Tensile Jig (needed accessory)
- B290-07** Deformation gauge
- B290-02** Displacement transducer (10 mm) (2 optional pieces)

## B254-02 KIT AASHTO | ASTM SCB testing kit

STANDARDS: AASHTO TP 124 Determining the fracture potential of asphalt mixtures using semicircular bend geometry (SCB) at intermediate temperature

ASTM D8044 Evaluation of asphalt mixture cracking resistance using the semi-circular bend test (SCB) at intermediate temperature

AASHTO TP105 Determining the fracture energy of asphalt mixtures using the semicircular bend geometry (SCB)

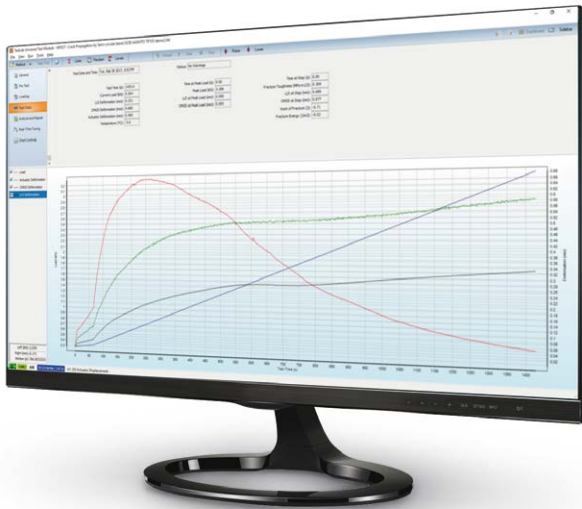

### TEST FRAMES

DTS-30 | DTS-130

### B254-02 KIT AASHTO | ASTM SCB testing kit

Comprises:

- B208** SCB frame
- B254-10** Roller support
- B254-02** Springs and roller



### OPTIONAL ACCESSORIES for AASHTO TP 124, ASTM D8044

- B290-02** LVDT (10mm) (1 or 2)
- B254-11** LVDT mounting assembly (q,ty according to B290-02)
- B254-12** Positioning device

### NEEDED ACCESSORIES for AASHTO TP105

- B254-13** Gauge point template
- B254-14** LVDT mounting hardware (2 **needed**)
- B254-15** LVDT mounting frame (2 **needed**)
- B253-53** Gauge point (2 **needed**)
- B290-05** LVDT 2.00 mm (2 **needed**) or  
**B290-06** LVDT 1.00 mm (2 **needed**)
- B290-07** SCB deformation gauge or  
**B290-16** Epsilon (model 3541) clip-on gauge CMOD  
transducer -1/+2.5 mm + **C090-18** Knife edge  
(pack of 24 only for B290-16)

## B282 KIT Thermal Stress Restrained Specimen Test - TSRST

STANDARDS: AASHTO TP10 Thermal Stress Restrained Specimen Tensile Strength  
 EN 12697-46 Low Temperature Cracking and Properties by Uniaxial Tension  
 TP Asphalt-StB 46A Cold properties: uniaxial tensile stress test and thermal stress restrained specimen test

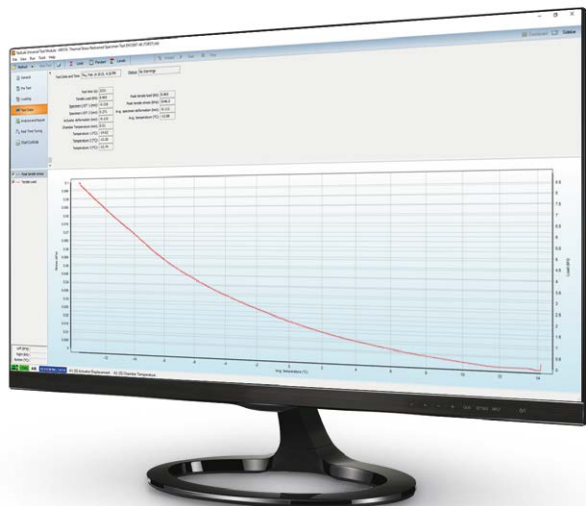

### TEST FRAMES

DTS-30 | DTS-130 (B232)

**B282 KIT** Thermal Stress Restrained Specimen Test

Comprises:

- B282-01** TSRST Temp Transducer (-80°C to +80°C) (3 pieces)
- B282-02** Rod End (2 pieces)
- B282-03** Clevis Yoke and Pin (2 pieces)
- B282-04** Platen (2 pieces)
- B282-05** LVDT Holder (2 pieces)
- B282-06** Invar Rod (250 mm long) (2 pieces)
- B282-07** Multi tack adhesive squares

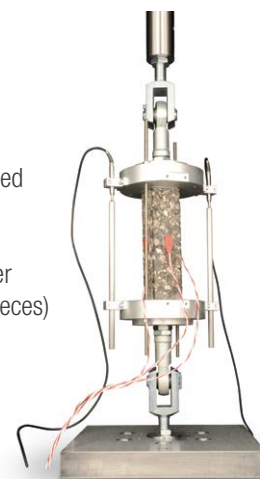

### ACCESSORIES

- B290-09** Displacement transducer (5 mm) (2 pieces **needed**)
- B261-01** B230 tension base (**needed** accessory for DTS-30)
- B282-08** TSRST specimen gluing jig (1 piece **needed**)
- B201-52** 5 minute, two part epoxy 24 ml

## B284-01 Disk Shaped Compact Tension Test Kit - DC(T)

STANDARD: ASTM D7313-07a Determining fracture energy of asphalt aggregate mixtures using the disk-shaped compact tension geometry

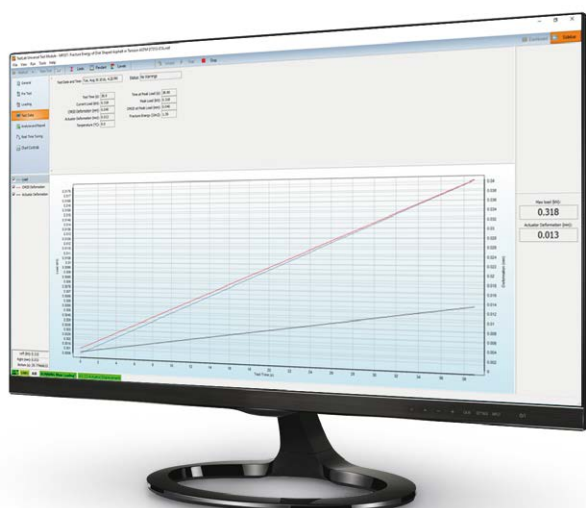

### TEST FRAMES

DTS-30 | DTS-130 (B231 or B232)

**B284-01** Disk Shaped Compact Tension Test Kit



### ACCESSORIES

- B261-01** B230 tension base (**needed** accessory for DTS-30)
  - B290-07** Deformation gauge (**needed** accessory)
- or
- B290-12** Epsilon Clip-On gauge 12.5 mm +1/-7 mm (**needed** accessory)
  - C090-18** Knife edge (Pack of 24) only for B290-12

## B264 KIT Direct tension testing kit - DTT

STANDARDS: EN 12697-26 Annex E - Test applying direct tension to cylindrical specimens (DT-CY) or to prismatic specimens (DT-PR)  
EN 12697-26 Annex D - Direct tension-compression test on cylindrical specimens (DTC-CY)  
AASHTO TP 107-14 Standard Method of Test for Determining the Damage Characteristic Curve of Asphalt Mixtures from Direct Tension Cyclic Fatigue Tests

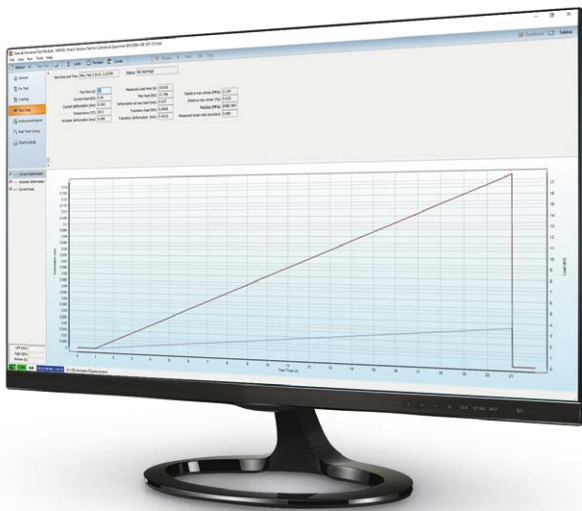

### TEST FRAMES

DTS-30 | DTS-130 (B232)



### B264 KIT Direct tension testing kit

Comprises:

**B261-02** Spherical seat coupling (2 pieces)

**B261-03** 100 mm tension platen (2 pieces)

### ACCESSORIES

**B253-04** LVDT mounting (3 pieces **needed**) jig

**B290-06** LVDT (1 mm) (3 pieces **needed**)

**B253-05** Screwdriver hex bit with spherical head size 2 mm

**B201-52** 5 Minute, two part epoxy 24 ml

**B202** Gauge point fixing jig

**B202-04** Spacer for 130 mm specimen height to be used with B202 (optional)

**B253-53** Gauge Point (24 pieces)

**B261-01** B230 tension base (**needed** accessory for DTS-30)

### AASHTO TP 107-14 ON SMALL SPECIMENS | DTS-30/130

To test 38 mm (diameter) x 110 mm (h) specimens with DTS-30/130 unit, the following items are required:

**B200-11** 38MM AMPT tension platen (2 pieces needed)

**B261-02** Spherical seat coupling

**B202** Gauge Point Fixing Jig

**B202-02** Spacer for 110 mm specimen height to be used with gauge point fixing jig B202

**B202-03** 38 mm and 50 mm diameter specimen - extension for gauge point fixing jig plungers B202

**B253-04** LVDT mounting (3 pieces needed) jig

**B290-06** LVDT (1 mm) (3 pieces needed)

**B253-05** Screwdriver hex bit with spherical head size 2 mm

**B201-52** 5 Minute, two part epoxy 24 ml

**B253-53** Gauge Point (24 pieces)

To test 50 mm (diameter) x 135 mm (h) specimens with DTS-30/130 unit, the following items are required:

**B200-12** 50MM AMPT tension platen (2 pieces needed)

**B261-02** Spherical seat coupling

**B202** Gauge Point Fixing Jig

**B202-01** Spacer for 135 mm specimen height to be used with gauge point fixing jig B202

**B202-03** 38 mm and 50 mm diameter specimen - extension for gauge point fixing jig plungers B202

**B253-04** LVDT mounting jig (3 pieces needed)

**B290-06** LVDT (1 mm) (3 pieces needed)

**B253-05** Screwdriver hex bit with spherical head size 2 mm

**B201-52** 5 Minute, two part epoxy 24 ml

**B253-53** Gauge Point (24 pieces)

## B204 KIT

### Overlay kit according to ASTM WK26816

STANDARD: ASTM WK26816 New Test Method for Determining the Susceptibility of Asphalt Mixtures to Cracking

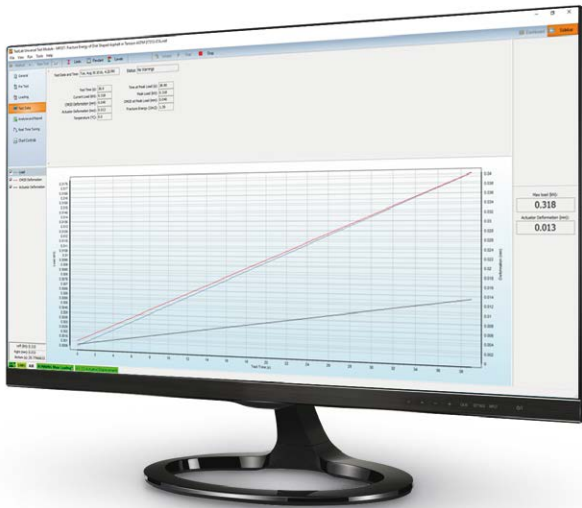

#### TEST FRAMES

Manual DTS-16 | Motorized DTS-16 (B221)  
 DTS-30 | DTS-130 (B231 or B232)



**B204 KIT** Overlay kit according to ASTM WK26816

Comprises:

**B204-01** Overlay jig

**B204-02** Pair of overlay tester (OT) specimen plates

**B204-03** OT specimen preparation jig according to ASTM WK26816

#### NEEDED ACCESSORIES

**B261-01** DTS-30 tension base

**B261-02** Spherical seat coupling

**B290-05** LVDT 2.00 mm or **B290-06** LVDT 1.00 mm

## B204-01 KIT

### Overlay kit according to TEX-248-F

STANDARD: TxDOT Designation. TEX-248-F Test Procedure for Overlay Test

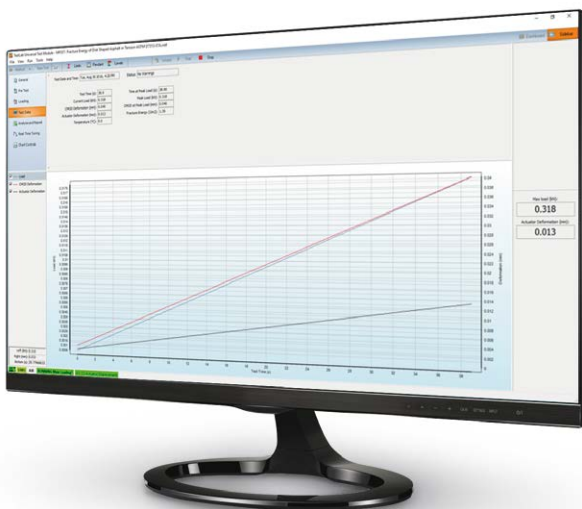

#### TEST FRAMES

Manual DTS-16 | Motorized DTS-16 (B221)  
 DTS-30 | DTS-130 (B231 or B232)



**B204-01 KIT** Overlay kit according to TEX-248-F

Comprises:

**B204-01** Overlay jig

**B204-02** Pair of overlay tester (OT) specimen plates

**B204-13** OT specimen preparation jig according to TEX-248-F

#### NEEDED ACCESSORIES

**B261-01** DTS-30 tension base

**B261-02** Spherical seat coupling

**B290-05** LVDT 2.00 mm or **B290-06** LVDT 1.00 mm

## B210 KIT STAND-ALONE SERVO-PNEUMATIC FOUR POINT BENDING (4PB) SYSTEM

STANDARDS: EN 12697-24 Annex D | EN 12697-26 Annex B | AASHTO T321 | ASTM 03 | ASTM-D7460

The Pavetest Servo-pneumatic Four Point Bending (4PB) System is a servo-pneumatic testing machine utilizing digital control of a high performance servo valve to provide accurate loading wave shapes up to 60Hz. The 4PB system can be operated in haversine or sinusoidal, controlled strain or sinusoidal controlled stress mode to determine the flexural stiffness/modulus and resistance to fatigue of asphalt beams of various sizes.

### MAIN FEATURES

- Robust four point loading frame.
- Backlash free rotation and translation on all load and reaction points.
- Fully configurable to suit a large range of testing applications.
- High performance servo-valve.
- Long life pneumatic actuator.
- Digital Servo-pneumatic control.
- 2 axis control and 8 channel data acquisition.



**B210-01**  
Servo-pneumatic four point apparatus

**B210 KIT** comprises:

- **B210-01** Servo-pneumatic Four Point Bending (4PB) Device with 10 mm actuator LVDT,  $\pm 5$  kN load cell, and 2 mm On-specimen LVDT
- **B205** 8 Channel Control and Data Acquisition System (CDAS) & TestLab software
- **B270-12** Air reservoir assembly with membrane dryer

It requires pressurized air, minimum 7 bar (not included)

The 4PB System is underpinned by Pavetest's leading edge CDAS digital controller, TestLab software and a full complement of accessories, hardware and software in perfect unison.

## TECHNICAL SPECIFICATIONS

### Load frame

- Outer clamp span 355.5 mm (14") and 420 mm
- Nominal beam size(s): 50 mm (h) x 50 mm (w)  
50 mm (h) x 63.5 mm (w)  
70 mm (h) x 70 mm (w)  
70 mm (h) x up to 85 mm (w)

### Servo actuator

- Capacity  $\pm 5$  kN
- Frequency Up to 60Hz;
- Stroke 10 mm
- Air supply clean dry air
- Pressure 800-900 kPa
- Minimum rate up to 5 litres/sec

### On-specimen transducer

- Range  $\pm 1$  mm
- Resolution 0.0002  $\mu$ m
- Accuracy Better than 5  $\mu$ m

**Power Supply:** 90-264V 50/60Hz 1ph 240W (B210 KIT)

**Dimensions:** 590(h) x 250(d) x 570(w) mm (B210-01)  
410(h) x 250(d) x 570(w) mm (B212)

**Weight:** 45 kg approx. (B210-01)  
35 kg approx. (B212)

## NEEDED ACCESSORIES

- B210-02** 4PB PVC Beam
- B210-03** 4PB Reference beam
- B250-07 KIT** Temperature measuring kit comprising:
  - **B292-01** Temperature transducer (-80 °C to +80 °C) (2 pieces)
  - **B250-10** Dummy asphalt specimen
  - **B250-11** 100 mm O ring (3 pieces)
  - **B250-12** Thermal conducting grease (about 56 g)

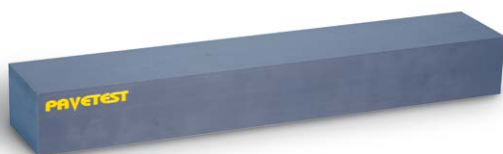

**B210-02** PVC Beam



**B210-01** Servo-pneumatic four point apparatus, detail

## RECOMMENDED ACCESSORIES

- B221** Temperature controlled cabinet: -20 °C to +70 °C to suit DTS-16 or 4PBA
- H009-01EN** PC complete with LCD monitor 22", keyboard, mouse, cables and installation of Testlab software

### 4PBA on DTS16:

- B210-01** Servo-pneumatic Four Point Bending (4PB) device with 10 mm actuator LVDT,  $\pm 5$  kN load cell and 2 mm Onspecimen LVDT (sharing CDAS with DTS 16)

It requires pressurized air (not included).

### 4PBA on DTS30:

- B212** 4PB JIG (sharing CDAS with DTS 30)

### 4PBA on DTS130:

- B210-01** Servo-pneumatic Four Point Bending (4PB) device with 10 mm actuator LVDT,  $\pm 5$  kN load cell and 2 mm Onspecimen LVDT (sharing CDAS with DTS 130)

- B270-12** Air reservoir assembly with membrane dryer

It requires pressurized air (not included).



**B270-12**  
Air reservoir assembly with membrane dryer

The specimen is securely clamped using servo-motor driven ball screws to maintain the prescribed clamping force and accommodate any compliance of the specimen between the clamping surfaces, during the test. The clamping force is controlled by regulating the motor current.

An on-specimen (LVDT) displacement transducer is used to measure and control the deflection at the centre of the beam with respect to the outer load/reaction points, as prescribed in the relevant standards.

Specimen alignment guide

Specimen height spacer to adjust the height of the specimen



A low profile, high performance stainless steel ring torsion load cell is used to measure and control the load.

The servo-pneumatic system uses a bottom loading pneumatic actuator coupled to a high performance servo valve, with PID closed-loop control and run time adaptive control to achieve/maintain the requested strain/stress for the duration of the test.

Inner and outer clamp control switches, located on the front of the device, are used to activate and release the inner and outer specimen clamps. The four specimen yokes provide backlash free rotation and translation at all load and reaction points.



**B200 | B200L**
**AMPT (SPT)**
**ASPHALT MIXTURE PERFORMANCE TESTER**

COMPACT, FULLY SELF CONTAINED, PRECISION ENGINEERED UNIT

The Pavetest AMPT is a servo-hydraulically controlled testing machine specifically designed to perform the three asphalt tests developed under NCHRP Projects 9-19 and 9-29; Dynamic Modulus, Flow Number and Flow Time. It is also the prescribed equipment in AASHTO T378 -17 Standard Method Test for Determining the Dynamic Modulus and Flow Number for Hot Mix Asphalt (HMA) using the Asphalt Mixture Performance Tester (AMPT). In addition, the Pavetest AMPT can also perform AASHTO TP107 -17 for Determining the Damage Characteristic Curve and Fatigue Analysis Parameters of Asphalt Mixtures in the AMPT, Indirect Tensile Dynamic Modulus, Incremental Repeated Load Permanent Deformation, Semi-circular bend, and Overlay Testing of Asphalt Mixtures.

The Pavetest AMPT is underpinned by Pavetest's leading edge CDAS digital controller, TestLab software and a full complement of accessories, hardware and software in perfect unison.

**MAIN FEATURES**

- Thermoelectric (TE) Heating/Cooling  
More reliable and environmentally friendly than mechanical refrigeration & heating elements.
- The unit can be equipped with water cooled TE heating/cooling technology (optional).
- Magnetically mounted on-specimen transducer system, based on loose core LVDTs or optional epsilon extensometers.
- Gauge point fixing jig facilitates gluing gauge points and the (top and bottom) platens for proposed AMPT Direct Tension Cyclic Fatigue (S-VECD) Test.
- Dynamic Verification Device.
- Dynaflo™ HPS provides dynamic speed control of the pump motor ensuring quiet operation.
- Optional built-in, silent, air compressor with associated air preparation equipment.

The machine includes:

- 8 Channel Control and Data Acquisition System (CDAS) & TestLab software
- 30 mm Actuator LVDT
- Load cell ( $\pm 20$  kN)
- Pressure transducer ( $\pm 300$  kPa)
- Temperature transducer ( $-80$  °C to  $+ 80$  °C)
- Magnetically mounted on-specimen LVDT (2 mm) (3 pieces)
- 105 mm bottom loading platen
- 105 mm top loading platen

It requires pressurized air, minimum 7 bar (not included).



**B200 AMPT/SPT Asphalt Mixture Performance Tester**

## TECHNICAL SPECIFICATIONS

<b>Load capacity:</b>	19kN (Static) - 17kN (Dynamic)
<b>Actuator stroke:</b>	30 mm
<b>Specimen size:</b>	100 mm (diameter) x 150 mm (h)
<b>Temperature range:</b>	0 °C to 70 °C (B200) -10 °C to 70 °C *(B200L)
<b>Confining pressure:</b>	0 to 225 kPa
<b>Noise level:</b>	Less than 70 db at 2 m
<b>Power Supply:</b>	110/230V 50-60Hz 1ph 3.5kW (B200   B200L)
<b>Dimensions:</b>	1510(h) x 680(d) x 1200(w) mm 1870(h) x 680(d) x 1200(w) mm with raised cell
<b>Weight:</b>	330 kg approx. (including oil)

\* At an ambient temperature of +23 °C

## NEEDED ACCESSORIES

**B201 KIT** AMPT Consumables kit. Comprises:

- **B253-53** Gauge point (24 pieces)
- **B201-52** 5 Minute, two part epoxy 24 ml
- **S311-03** 100 mm Sealing Rings (Pack of 10)
- **B201-53** 100 mm Rubber membrane 0.3 mm thickness (Pack of 10)
- **B200-10** Latex membrane material cut in 100mm diameter discs (needed for AASHTO T378)
- **B200-04** 100 mm AMPT tension platens (2 **needed** pieces) for S-VECD test



**B200-04** 100 mm AMPT tension platens

## OPTIONAL ACCESSORIES

- B270-18** Membrane stretcher for asphalt specimen Ø 100 mm (optional)
- B200-09** Spacer to enable 130mm tall specimens to be tested in tension/compression (S-VECD test on small specimens)
- B200-13** AMPT silent air compressor
- B200-13X** AMPT silent air compressor 230V 60Hz



Asphalt specimen  
with on-specimen LVDTs and load cell

## RECOMMENDED ACCESSORIES

- B202** Gauge Point Fixing Jig
- B202-04** Spacer for 130 mm specimen height to be used with gauge point fixing jig B202
- B203** AMPT Dynamic Verification Device
- H009-01EN** PC complete with LCD monitor 22", keyboard, mouse, cables and installation of Testlab software



**B202** Gauge point fixing jig



**B203** AMPT Dynamic Verification Device

**TESTING KITS**

**B204 KIT** Overlay kit according to ASTM WK26816. Comprises:

- **B204-01** Overlay jig
- **B204-02** Pair of Overlay Tester (OT) specimen plates
- **B204-03** OT specimen preparation jig according to ASTM WK26816

**B204-01 KIT** Overlay kit according to TEX-248-F. Comprises:

- **B204-01** Overlay jig
- **B204-02** Pair of overlay tester (OT) specimen plates
- **B204-13** OT specimen preparation jig according to TEX-248-F

**B207-01 KIT** AMPT Indirect Tensile (IDT) kit. Comprises:

- **B207-01** AMPT IDT Jig
- **B253-01** LVDT mounting Jig
- **B253-03** Gauge point template (150 mm specimen)
- **B290-04** AMPT Miniature LVDT (1 mm) (4 pieces)
- **B253-53** Gauge point (32 pieces)
- **B207-02** Cable gland (4 pieces)

**B254-02 KIT** AASHTO TP124 | ASTM D8044 SCB testing kit. Comprises:

- **B208** SCB frame
- **B254-10** Roller support
- **B254-02** Springs and roller



**B254-02 KIT** AASHTO TP124 | ASTM D8044 SCB testing kit

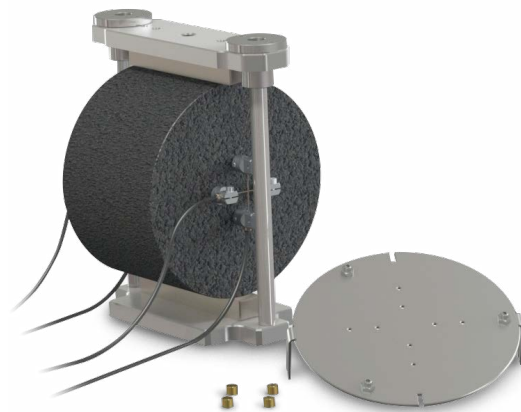

**B207-01 KIT** AMPT indirect tensile kit



**B204 KIT** Overlay kit according to ASTM WK26816

**CDAS - Control and Data Acquisition System**

Pavetest's compact Control and Data Acquisition System (CDAS) delivers unparalleled performance, real time control and ultimate versatility in acquisition.

The AMPT has a stand-alone CDAS, which is common to all Pavetest systems.



**B205** CDAS 8 channels

**SMALL SPECIMENS ACCESSORIES | AMPT**

For dynamic modulus on 38 mm (diameter) x 110 mm (h) specimen:

- B200-05** Bottom loading platen for 38 x 110 mm ( $\emptyset$  x h) specimen
- B200-06** Top loading platen for 38 x 110 mm ( $\emptyset$  x h) specimen
- B202** Gauge Point Fixing Jig
- B202-02** Spacer for 110 mm specimen height to be used with gauge point fixing jig B202
- B202-03** 38 mm and 50 mm diameter specimen - extension for gauge point fixing jig plungers B202
- B253-53** Gauge point (32 pieces)
- B201-52** 5 Minute, two part epoxy 24 ml
- S311** Sealing ring  $\emptyset$  38 mm (10 pcs)
- S310** Rubber membrane  $\emptyset$  38 mm (10 pcs)
- B270-20** Membrane stretcher for asphalt specimen  $\emptyset$  38 mm

For S-VECD test on 38 mm (diameter) x 110 mm (h) specimen:

- B200-11** 38MM AMPT tension platen (2 pieces needed)
- B202** Gauge Point Fixing Jig
- B202-02** Spacer for 110 mm specimen height to be used with gauge point fixing jig B202
- B202-03** 38 mm and 50 mm diameter specimen - extension for gauge point fixing jig plungers B202

For dynamic modulus on 50 mm (diameter) x 135 mm (h) specimen:

- B200-07** Bottom loading platen for 50 x 135 mm ( $\emptyset$  x h) specimen
- B200-08** Top loading platen for 50 x 135 mm ( $\emptyset$  x h) specimen
- B202** Gauge Point Fixing Jig
- B202-01** Spacer for 135 mm specimen height to be used with gauge point fixing jig B202
- B202-03** 38 mm and 50 mm diameter specimen - extension for gauge point fixing jig plungers B202
- B253-53** Gauge point (32 pieces)
- B201-52** 5 Minute, two part epoxy 24 ml
- S311-01** Sealing ring  $\emptyset$  50 mm (10 pcs)
- S310-01** Rubber membrane  $\emptyset$  50 mm (10 pcs)
- B270-21** Membrane stretcher for asphalt specimen  $\emptyset$  50 mm

For S-VECD test on 50 mm (diameter) x 135 mm (h) specimen:

- B200-12** 50MM AMPT tension platen (2 pieces needed)
- B202** Gauge Point Fixing Jig
- B202-01** Spacer for 135 mm specimen height to be used with gauge point fixing jig B202
- B202-03** 38 mm and 50 mm diameter specimen - extension for gauge point fixing jig plungers B202



**B202** Gauge Point Fixing Jig + accessories for small specimens preparation

## B215 SERVO-PNEUMATIC OVERLAY TESTER

The Pavetest Overlay Tester is a servo-pneumatic controlled testing machine utilizing digital control of a high performance servo valve to provide accurate loading wave shapes up to 60Hz, specifically designed to determine the susceptibility of asphalt mixtures to cracking according to Texas DOT test procedure Tex-248-F and proposed ASTM Standard WK 26816.

The machine applies cyclic loading to a specimen that is cut from a 150 mm diameter sample into the shape of a rounded end beam. The system comprises a load frame, with one fixed and one moving plate, temperature control system, Control and Data Acquisition System (CDAS) and optional silent air compressor. The specimen is glued to two plates and this assembly is placed in the machine for testing. This is intended to simulate the action of movement under an asphalt overlay to assess how failure might occur in the field due to factors such as thermal expansion / contraction and reflective cracking.

The Pavetest Overlay Tester is underpinned by Pavetest's leading edge CDAS digital controller, TestLab software and all the necessary accessories, hardware and software in perfect unison.

### MAIN FEATURES

- Compact, fully self contained, precision engineered unit.
- Thermoelectric (TE) Heating/Cooling - More reliable and environmentally friendly than mechanical refrigeration & heating elements.
- Optional silent, air compressor including membrane dryer.
- Built in verification (Dial gauge).
- Integral stand with wheels.

The machine includes:

- Load frame with one fixed and one moving plate
- 15 kN Servo-pneumatic actuator (10 mm stroke)
- 8 Channel Control and Data Acquisition System (CDAS) & TestLab software
- Load cell ( $\pm 15\text{kN}$ )
- 10 mm displacement transducer
- Thermoelectric Heating/Cooling system
- Temperature transducer  $-80\text{ }^{\circ}\text{C}$  to  $+80\text{ }^{\circ}\text{C}$

It requires pressurized air, minimum 7 bar (not included)



**B215** Overlay tester

## TECHNICAL SPECIFICATIONS

<b>Load Capacity:</b>	Up to 16 kN (Static)
<b>Actuator stroke:</b>	10 mm
<b>Temperature range:</b>	10 to 60 °C
<b>Noise Level:</b>	Less than 70 db at 2 m
<b>Power supply:</b>	110/230V 50-60Hz 1ph 750W (B215)
<b>Dimensions:</b>	980 (h) x 475 (d) x 1085 (w) mm
<b>Weight:</b>	150 kg approx.

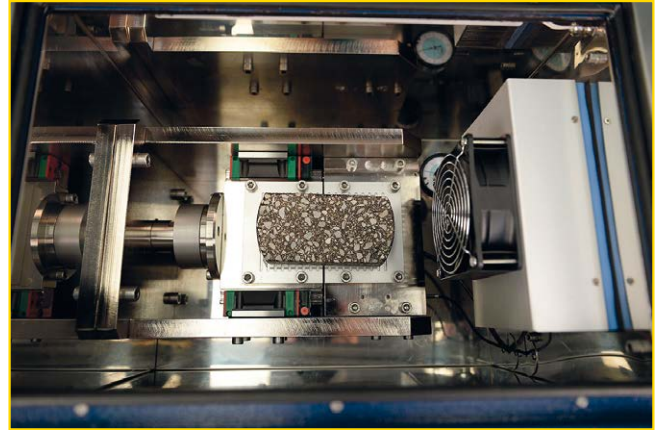

**B215** Overlay tester: detail

## TECHNICAL FEATURES

- **Temperature controller.** The overlay tester is fitted with a temperature controller, which controls the heating/cooling provided by the thermo-electric unit fitted to the machine.
- **The specimen preparation jig allows users to properly locate and glue the specimen on plates.** It can accommodate up to three sets of platens. It includes 2 mm teflon strip, which helps aligning the specimen plates and eliminate the need to saw the glue afterwards, and a dead weight.
- **The Overlay Tester main unit comes fully assembled.** It can be placed on the folding stand supplied, complete with wheels.

## NEEDED ACCESSORIES

**B204-02** Pair of specimen plates

**B204-03** OT specimen preparation jig according to ASTM WK 26816

**B204-13** OT specimen preparation jig according to Tex-248-F

**Note:** The quantity depends on the customer's need.

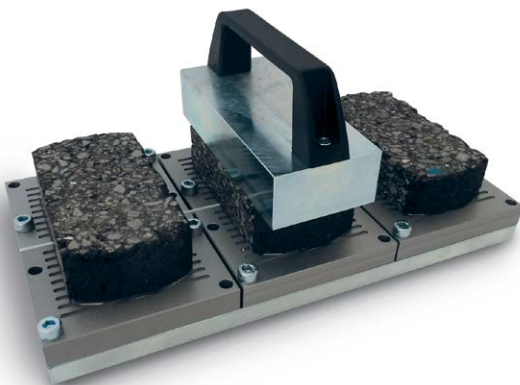

**B204-03** Specimen preparation jig



Detail of the wheels



**B204-02** Specimen plates

## OPTIONAL ACCESSORIES

**B204-11** Silent air compression 750W 230V 50Hz

**B204-11X** Silent air compression 750W 230V 60Hz

## TSRST-MULTI

### MULTI STATION THERMAL ASPHALT SYSTEM

STANDARDS:

**AASHTO TP10-1993** Standard test method for Thermal Stress Restrained Specimen Tensile strength

**EN 12697-46:2012** Test methods for hot mix asphalt Part 46: Low temperature cracking and properties by uniaxial tension tests

## FIRST STAND ALONE SERVO-HYDRAULIC TSRST

### MAIN FEATURES

- Up to three working stations (electromechanical and/or servo-hydraulic stations).
- Servo-hydraulic actuator: 30 kN static, 25 kN dynamic, double acting, fatigue rated and equal area type with long life Labyrinth bearings & seals.
- Dynaflo™ Hydraulic Power Supply: Variable Frequency Drive 2.2 kW pump motor; Silent operation.
- Ability to clone, modify and/or generate user's own method file(s) to suit their specific requirements.
- Programmable test Wizard to guide the operator step by step based on a recipe book approach.
- Temperature controller programmed via PC software.



TSRST-MULTI STATION

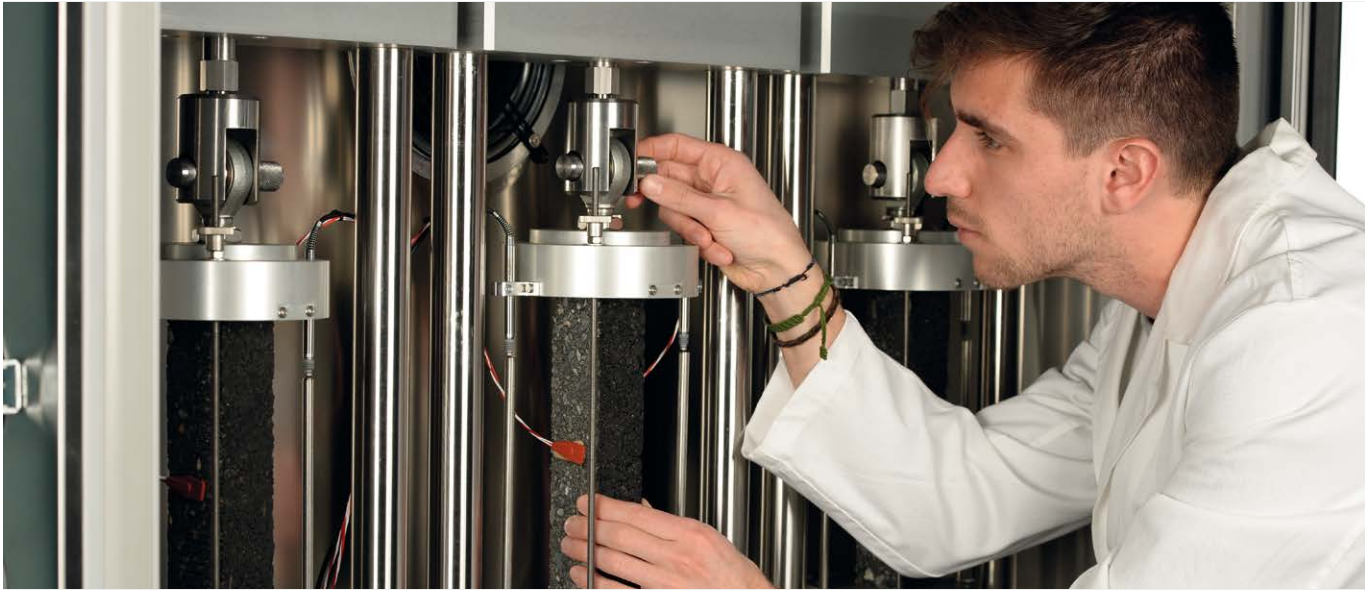

## PAVETEST TSRST-MULTI: THE NEXT GENERATION OF MULTI-STATION THERMAL ASPHALT SYSTEM

The **Thermal Stress Restrained Specimen Test (TSRST)** is used to determine the low temperature cracking susceptibility of asphalt concrete. In the early 1990s the TSRST was developed by Oregon State University (OSU) as part of the Strategic Highway Research Program. The test method became AASHTO TP10.

# 1

### FIRST STAND-ALONE SERVO-HYDRAULIC TSRST ON THE MARKET

With up to three servo-hydraulic testing station in one unit, Pavetest TSRST-Multi is **the first stand-alone servo-hydraulic low temperature** cracking asphalt testing system **on the market** able to test up to three different specimens simultaneously, under the same temperature conditions.

### FLEXIBLE

Designed with flexibility in mind, **Pavetest** TSRST-multi can use different combinations of servo-hydraulic and/or electro-mechanical testing stations with **no need for a compressed air supply**.



### VERSATILE

Pavetest versatile TSRST-Multi can be used to evaluate:

- Uniaxial tension stress test (UTST)
- Thermal stress restrained specimen test (TSRST)
- Relaxation time, using the relaxation test (RT)
- Tensile creep tests (TCT)
- Uniaxial cyclic tension stress test (UCTST)
- Uniaxial thermal stress & strain test (UTSST) it requires additional hardware



### POWERFUL

Equipped with Pavetest's leading edge Control and Data Acquisition System (CDAS) and TestLab software, the user can control up to 3 testing stations in one unit, with unparalleled performance and ultimate versatility.







### EASY TO OPERATE

Pavetest TestLab software makes it easy to operate the system because it enables the operator to program the temperature controller with ease.



### SAFE

Pavetest TSRST-Multi employs a reliable refrigeration system, capable of cooling at a rate of 10° per hour. **Mechanical refrigeration eliminates the need for liquid nitrogen**, offering a completely safe working environment for the operator.



### QUIET

The **Electro-mechanical and/or dynamically controlled hydraulic power supply are almost silent during testing.**



### DYNAFLO™

The servo-hydraulic station(s) are powered by the Dynaflo Hydraulic Power Supply (HPS). The **Dynaflo HPS is an innovative concept based on “inverter” technology**: An inverter is used to control the speed of the pump motor to control hydraulic oil flow based on the requirements; **reducing noise and heat generation**, rendering the HPS silent in most applications. It also **improves the longevity of the pump** because it only works as hard as it needs making it quiet, cool and long lasting.

## THE DYNAFLO™ CONCEPT

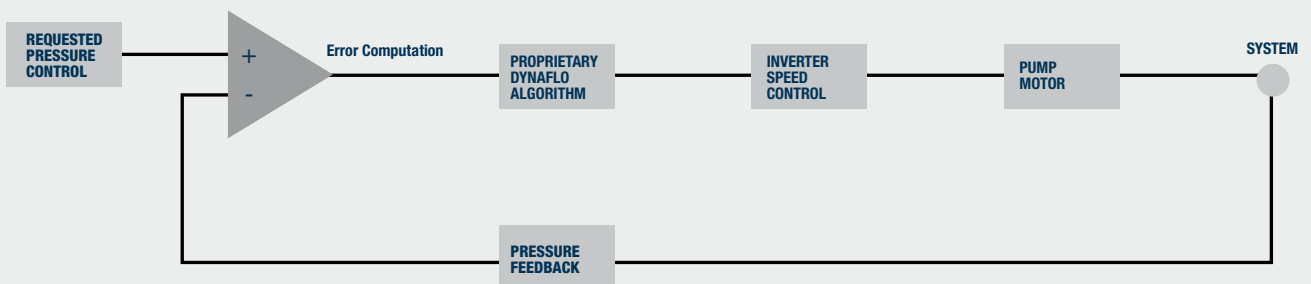

The **environmental chamber** is constructed from **top quality stainless steel**; stylish, durable and easy to clean.

**Mechanical refrigeration** capable of cooling at  $-10\text{ }^{\circ}\text{C}$  per hour down to  $-40\text{ }^{\circ}\text{C}$ ; no need for liquid nitrogen.

The **modular concept** allows the system to be configured in any combination of, **up to three electro-mechanical and/or servo-hydraulic stations**, without the need for compressed air supply.

The **high performance digital temperature controller** can be programmed through the software; eliminating the arduous task of setting the controller using the tiny buttons on the controller.

**Triple glazed, low-e glass door offers** excellent insulation without compromising visibility.

**Internal lighting** ensures good visibility under all conditions.

Uniquely **low coefficient of thermal expansion invar rods** offer accurate measurement and control over the full temperature spectrum.

**Axial alignment** is achieved using self-aligning couplings.

**Small footprint** makes best use of precious laboratory space.

**Only** requires **electrical power** for easy installation.

**Fully integrated digital control and data acquisition system (CDAS).**



## CONTROL AND DATA ACQUISITION SYSTEM (CDAS)



**B206 16 CHANNEL CDAS**

### CONTROL:

- High speed, (18 bit) digital servo-control, 4/6 axis.
- Digital closed loop update sampling rate of 2.5 kHz.
- Computer programmable, Proportional, Integral and Derivative (PID) control algorithm.
- Adaptive Level Control (ALC) algorithm for best dynamic peak accuracy.
- 3 feedback control modes. E.g. force, position and on-specimen strain.
- “Bumpless transfer” between control modes.

### ACQUISITION:

- Analog inputs are automatically calibrated on power up.
- Simultaneous sampling of all channels.
- 16 Analog ( $\pm 10$  Volt) input channels.
- Up to 64 times over sampling (set to 8 by default).
- 20 bit digital resolution (no auto ranging required).
- Sampling rate up to 192,000 samples/see.

### COMMUNICATION:

- USB or Ethernet

### ENVIRONMENTAL CHAMBER

- REFRIGERATION RANGE: -40 °C to + 40 °C, capable of cooling at a rate of 10 °C per hour.
- Optional: -50 °C to + 40 °C version (for AASHTO TP 10 test).

**Real Time Dashboard** display shows transducer levels, computed data and charted data before, during and after the test has completed.

Dynamic image update feature shows visual image representation of specimen failure Multi- axes representation for clear visual presentation of test status for each axes.

Very user friendly presentation simplifies specimen setup in the machine.

The dashboard display feature of Testlab provides the user with an intuitive visual representation of the current status of both the machine and test method. The dashboard shows live transducer level measurements along with nominated key test data information and real time chart updates. This feature is individually customisable for each method file. Pavetest has already available dashboard designs for the more sophisticated tests including multi station TSRST.

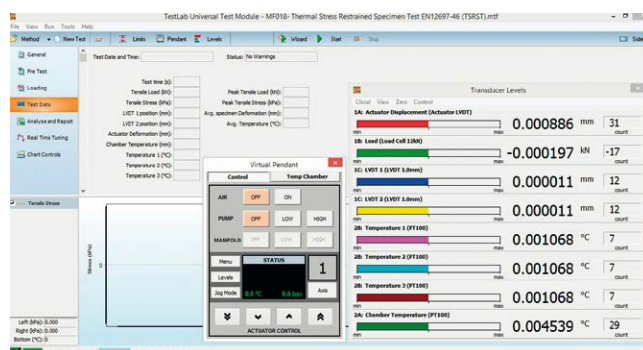

**TestLab Universal Test Module**

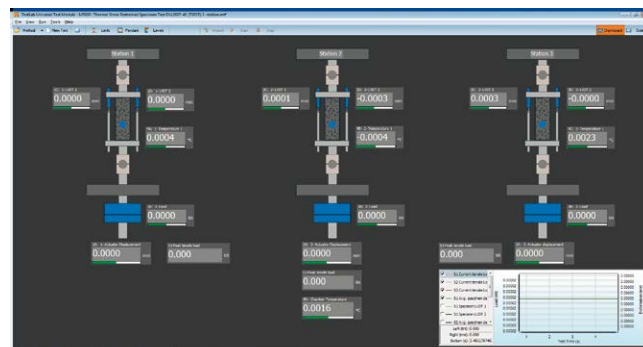

**TSRST-Multi Dashboard**

## TECHNICAL SPECIFICATIONS

### External dimensions load frame (including environmental chamber):

1853(h) x 1020(d) x 1230(w) mm

### Hydraulic Power Supply (for Servo-hydraulic station(s)):

700(h) x 520(d) x 570(w) mm

**Weight load frame:** 200 kg approx. without the selected stations configuration

### Electrical requirement for:

**Servo-hydraulic station (each):** 230V 50-60Hz 1ph 2.2kW

### Electro-mechanical station (each):

100-230V 50-60Hz 1ph 0.75kW

**Refrigeration unit:** 380-420V 50Hz 3ph 2.5kW

### Loading frame(s)

- Rigid two column frame
- Width of work space: 240 mm
- Height of work space (between the two platens): 285 mm

### Electro-mechanical actuator(s)

- 25kN static with  $\pm 50$  mm stroke (100 mm)
- Internal displacement transducer

### Servo-hydraulic actuator

- 30kN static, 25kN dynamic, double acting, fatigue rated, servo hydraulic actuator, equal area type with long life seals & bearings
- $\pm 50$  mm stroke (100 mm)
- Internal displacement transducer
- Close coupling of servo valve to actuator for best servo performance
- 10  $\mu$ m pressure line filter at actuator for ultimate contamination control
- 0.5 lt hydraulic accumulator with 40 Bar pre-charge for best pressure line regulation at servo-valve.
- High response, VCD direct drive, servo-valve: -3 db @ 350 Hz,  $\pm 5\%$  amplitude (performance curves available on request)

### Load cell(s)

- Low profile Precision Transducers load cell,  $\pm 30$ kN, 0.1%. Normalized output with in-line signal conditioning

### Hydraulic power supply

- Working pressure of up to 160 Bar (low pressure adjustable)
- High/Low pressure selectable from control pendant
- Variable flow rate up to 7.5 liter/min
- Variable Frequency Drive (VFD) 2.2kW pump motor; speed based on demand
- 3  $\mu$ m return line filtration
- Low oil, over temperature and dirty filter displayed
- Remote starting
- Pressure gauge
- Air cooling (Electric fan)



**B282-08** TSRST specimen gluing jig (needed accessory)

Simple and easy to use gluing jig for preparing TSRST specimens. The jig provides for perfect alignment and adjustment for different sized specimens. The clamping force is easily set and ensures the end plates are glued perpendicular to the specimen.

### ORDERING INFORMATION

The basic MULTI TSRST includes the main frame, the CDAS, the climatic chamber, the refrigeration unit and at least one between the electro-mechanical or servo-hydraulic station. All available configurations are summarized in the following table:

	ELECTROMECHANICAL STATION	SERVO-HYDRAULIC STATION
<b>B282-10</b>	1	-
<b>B282-11</b>	2	-
<b>B282-12</b>	3	-
<b>B282-13</b>	-	1
<b>B282-14</b>	1	1
<b>B282-15</b>	2	1

#### Note:

Multiple stations configuration (B282-11, B282-12, B282-14, B282-15) allow to run tsrst tests with all stations simultaneously. In this configurations, utst, rt, tct, utsst and utcst tests are performed on one station at a time. With combined configuration (electromechanical and servo-hydraulic) utcst must be performed with servo-hydraulic station.

### TO PERFORM

- Uniaxial tension stress test (UTST)
- Thermal stress restrained specimen test (TSRST)
- Relaxation time, using the relaxation test (RT)
- Tensile creep tests (TCT)
- Uniaxial cyclic tension stress tests (UCTST)\*\*
- Uniaxial thermal stress & strain test (UTSST)\*\*\*

\*\* Only applicable to servo-hydraulic work station(s)

\*\*\* Additional hardware required

### ACCESSORIES

**B282-08** TSRST specimen gluing jig (needed)

**B282-18** TSRST proof test assembly (optional)

Disk Shaped Compact Tension test:

**B284-01** Disk-shaped compact tension test jig

**B282-02** Rod ends (2 pieces needed)

**B290-07** SCB deformation gauge (needed)

or

**B290-12** Epsilon (model 3541) clip-on gauge cmod transducer +1/-7 mm (Alternative to B290-07)

**C090-18** Knife edge (pack of 24) only for B290-12

## B225 STS-25 STATIC TESTING SYSTEM

### THE MOST VERSATILE TESTING MACHINE IN THE MARKET

STANDARDS: ASTM D7313-07a | AASHTO TP105-13 | AASHTO TP124 | ASTM D8044 | ASTM WK 26816 | AASHTO T 314-12  
 AASHTO TP10-1993 | TxDOT\_ Tex-248-F

The Pavetest 25kN Static Testing System (STS-25) is an electro-mechanical servo-controlled testing machine utilizing digital control of a high performance electro-mechanical actuator to provide accurate loading rates up to 50mm/minute, designed to perform a range of static tests; including: Overlay, SCB, DCT, TSRST and DTT

The STS-25 is underpinned by Pavetest's leading edge CDAS digital controller, TestLab software and a full complement of accessories hardware and software in perfect unison.

#### MAIN FEATURES

- Compact, fully self-contained, precision engineered unit.
- Precision electro-mechanical actuator (silent operation).
- Suitable for a range of testing protocols.
- A range of two piece climatic chambers.
- Operator can monitor, set and "Auto tune" the temperature controller via the PC.
- Optional swivel stand allows the unit to be oriented vertically or horizontally.

The machine includes:

- Rigid two column load frame
- 25 kN electro-mechanical actuator (30 mm stroke)
- 8 channel Control and Data Acquisition System (CDAS) & TestLab software
- Load cell ( $\pm 30$  kN)
- 30 mm actuator LVDT



**B225** STS-25 Static Testing System



Horizontal configuration complete  
with swivel stand B225-04

## TECHNICAL FEATURES

- **Electro-mechanical unit.** The machine applies constant rate of loading to a specimen that is placed in the load frame.
- **The system comprises** a load frame, with a load cell, integral displacement transducer, insulate cabinet, Control and Data Acquisition System (CDAS). The insulated chamber with small glass door reduces heat loss whilst providing uninterrupted view of the specimen.
- **Versatile.** An optional swivel stand allows the unit to be oriented vertically or horizontally; to suit the application.
- **Portable temperature control unit.** We offer three models of temperature control unit, with different temperature ranges, to cover a number of international testing standards.

## NEEDED ACCESSORIES

- B225-01** Temperature controlled cabinet - TE UNIT.  
+10 °C to +60 °C TO SUIT STS-25
- or
- B225-02H** Temperature controlled cabinet - REFR. UNIT.  
Horizontal configuration: -20 °C to +80 °C to suit STS-25
- or
- B225-03H** Temperature controlled cabinet - REFR. UNIT.  
Horizontal configuration: -40 °C to +80 °C to suit STS-25
- or
- B225-02V** Temperature controlled cabinet - REFR. UNIT.  
Vertical configuration: -20 °C to +80 °C to suit STS-25
- or
- B225-03V** Temperature controlled cabinet - REFR. UNIT.  
Vertical configuration: -40 °C to +80 °C to suit STS-25

## TECHNICAL SPECIFICATIONS

Load Capacity:	Up to 25kN
Actuator stroke:	30 mm
Testing space:	400 mm
Loading rate:	0.3mm/min. to 50mm/min.
Temperature range:	10 to 60 °C (thermoelectric unit) -20 to 80 °C or -40 to 80 °C (refrigeration unit)
Mains Power:	230V 50-60Hz 1ph (B225) 230V 50-60Hz 1ph (thermoelectric unit) 230V 50Hz 1ph (refrigeration unit)



Temperature  
controlled unit- REFR. UNIT



Temperature controlled cabinet - TE UNIT

## OPTIONAL ACCESSORIES

- H009-01EN** PC 22" with lcd screen
- B250-07-KIT** Temperature measuring KIT
- B225-04** swivel stand (only for B225-01)

For test configuration and related jigs, please consult p. 182-192

## B215EM ELECTRO-MECHANICAL OVERLAY TESTER

STANDARDS: ASTM WK 26816 Standard Test Method for Determining the Susceptibility of Asphalt Mixtures to Cracking Using the Overlay Tester  
 TxDOT Tex-2 48-F –Test Procedure for Overlay Test

The Pavetest Overlay Tester is an electro-mechanical servo-controlled testing machine utilizing digital control of a high performance electro-mechanical actuator to provide accurate loading rates up to 50 mm/minute, designed to determine the susceptibility of Asphalt Mixtures to cracking. Applies tension in a **cyclic triangular waveform** to a constant maximum displacement of 0.6 mm (0.026). The sliding block reaches the maximum displacement and then returns to its initial position in 10 sec. (one cycle). The unit is underpinned by Pavetest's leading edge CDAS digital controller, TestLab software and a full complement of accessories hardware and software in perfect unison.



Horizontal configuration

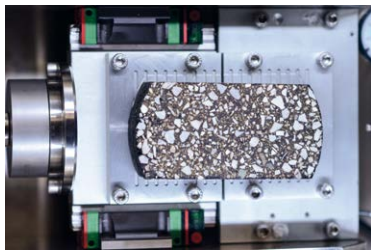

**B215EM** Electro-Mechanical Overlay Tester

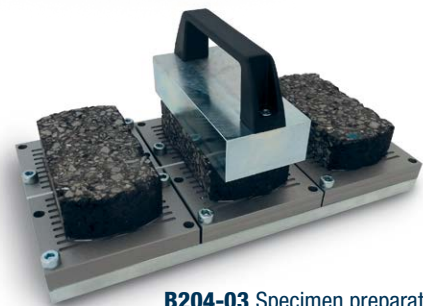

**B204-03** Specimen preparation jig

### NEEDED ACCESSORIES

- B225-01** Temperature controlled cabinet - te unit:  
 +10 °C to +60 °C
- or
- B225-02H** Temperature controlled cabinet - refr. unit.  
 Horizontal configuration: -20 °C to +80 °C
- B204-14** Overlay jig
- B290-02** OT LVTD (10 MM) to be used with Electro-mechanical  
 Overlay Tester
- B204-02** Pair of Overlay Tester (OT) specimen plates
- B204-03** OT Specimen preparation jig according to ASTM 26816
- or
- B204-13** OT Specimen preparation jig according to  
 TxDOT\_tex-248-F



**B204-02** Specimen plates

### OPTIONAL ACCESSORY

- H009-01EN** PC 22" with lcd screen

## B225-09 DTT DIRECT TENSION TESTER

STANDARDS: AAHSTO T 314-12 Determining the Fracture Properties of Asphalt Binder in Direct Tension

The Pavetest DTT Direct Tension Tester is an electro-mechanical servo-controlled testing machine utilizing digital control of a high performance electro-mechanical actuator to provide accurate loading rates up to 50 mm/minute, designed to determine the fracture properties of Asphalt binder in Direct Tension (DTT). The unit is underpinned by Pavetest's leading edge CDAS digital controller, TestLab software and a full complement of accessories hardware and software in perfect unison.



B225-09 DTT Direct Tension Tester



Horizontal configuration



B225-10

### NEEDED ACCESSORIES

**B225-03H** Temperature controlled cabinet - refr. unit.  
Horizontal configuration: -40 °C to +80 °C

**B225-10** Direct Tension jig complete with 25 mm on specimen displacement transducer.



Temperature controlled unit- REFR. UNIT

### OPTIONAL ACCESSORY

**H009-01EN** PC 22" with lcd screen



**ORDERING INFORMATION**

The unit can perform the following tests:

DC(T)	Disk-shape compact tension test
SCB	Semicircular bending test
OT	Overlay test
DT	Direct tension test
TSRST	Thermal stress restrained specimen tensile test

**STS-25 - Ordering info**

Test	Testing Kit/Jig/Accessories	Relevant standard(s)	With temperature controlled cabinet	Accessories
DC(T)	B284-01	ASTM D7313-07a	"(10°C greater than the low temperature PG of the asphalt binder) B225-02H or B225-02V or B225-03H or B225-03V	B290-07 needed or B290-12 + C090-18 needed
SCB	B254-02-KIT (B208+B254-10+B254-02)	AASHTO TP124 ASTM D8044	(25°C) B225-01+ optional B225-04 or B225-02V or B225-03V	B254-16 needed B290-02 (1or 2) optional B254-11 (according to B290-02 q.ty) optional B254-12 optional
SCB	B254-02-KIT (B208+B254-10+B254-02)	AASHTO TP105-13	(22°C greater than the low temperature PG of the asphalt binder) B225-02V or B225-03V	B254-16 needed 2 x B253-53 needed B254-13 needed 2 x B254-14 needed 2 x B254-15 needed 2 x B290-05 or 2 x B290-06 needed B290-07 or B290-16 + C090-18 needed
OT	B204-14	ASTM WK26816	(25°C) B225-01+ optional B225-04 or B225-02H or B225-03H	3 x B204-02 needed B204-03 needed B290-02OT needed
OT	B204-14	Tex 248F	(25°C) B225-01+ optional B225-04 or B225-02H or B225-03H	3 x B204-02 needed B204-13 needed B290-02OT needed
DTT	B225-10	AASHTO T314-12	(+6° to -40 °C) B225-03H	none
TSRST	B282-01-KIT (3 x B282-01+2 x B282-02 +1 x B282-21+1 x B282-09 +2 x B282-04+2 x B282-05 +2 x B282-06+B282-07)	AASHTO TP10	(-50°C to +10°C, capable of cooling at a rate of 10°C per hour) B225-03V	2 x B290-09 needed B282-08 needed B201-52 optional

**B040-20****ACD****AUTOMATED CORE DRILL**

Matest has developed an Automated Core Drill (ACD) for fast, accurate cutting of cores from cylinders, prisms and slabs prepared using Matest's range of asphalt compaction machines; GYROTRONIC-Gyratory Compactor, ASC-Asphalt Shear-box Compactor and field specimens for subsequent testing using Matest/Pavetest's range of leading edge testing systems.

**MAIN FEATURES**

- Three selectable drill speeds.
- Clear protective/splash screen conforming to CE standards.
- Ideal for coring prismatic specimens compacted in Asphalt Shear-box Compactor (ASC).
- Suitable to core cylindrical specimens compacted in Gyratory compactor(s).
- Includes water container/tray.
- Adjustable specimen clamp eliminates specimen movement during coring.
- Three position fixture provides easy and accurate specimen positioning.
- Three core supports at fixed spacing yields two or three cores from one prism.
- Optional cylindrical specimen jig.

**B040-20****SPECIFICATIONS**

Drill Bit Diamond/tungsten alloy, laser welded.  
Core diameter 100 mm or 150 mm.  
For other core diameters, see the accessories.  
Core height up to 40 cm.

Specimen sizes:

- Cylindrical Sample: 160 mm x 70 mm - 400 mm (ØxH)
- Prismatic Sample:  
200-450 mm x 150-185 mm x 120-420 mm (LxDxH)  
315-340 mm x 220-260 mm x 120-420 mm (LxDxH)

**Dimensions:** 60 cm (L) x 80 cm (D) x 140 cm (H)

**Net weight:** 85 kg

**Power supply:** 230V 10A 50Hz 1ph (540/1, 300/1, 800 rpm)  
230V 10A 60Hz 1ph (560/1, 330/1, 850 rpm)  
115V 20A 60Hz 1ph (560/1, 330/1, 850 rpm)

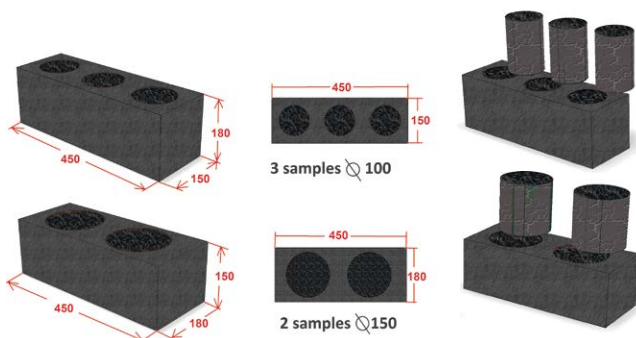
**ORDERING INFORMATION**

**B040-20** Asphalt Core Drill (230V/50-60Hz) for prisms

**B040-20Y** Asphalt Core Drill (110V/60Hz) for prisms

**ACCESSORIES**

**C339-03** Ø 100 x 420 mm long drill bit (needed)

**C339-04** Ø 150 x 420 mm long drill bit (needed)

**B040-21** Clamping cylindrical specimen jig to suit from 50 to 150 mm diameter specimens (needed)

**B040-22 KIT** DCT specimen. It includes:

■ **B040-22** DCT specimens drilling jig

■ **B040-33** Ø 25 x 420 mm long drill bit

**B040-23 KIT** Transversal coring. It includes:

■ **B040-23** Transversal coring jig

■ **C339-02** Ø 75 x 420 mm long drill bit

■ **B040-30** Ø 38 x 420 mm long drill bit

■ **C339-01** Ø 50 x 420 mm long drill bit

**B040-31** Ø 42 x 420 mm long drill bit

**B040-32** Ø 55 x 420 mm long drill bit

**C346** Core Extractor Ø 50 mm

**C346-01** Core Extractor Ø 75 mm

**C346-02** Core Extractor Ø 100 mm

**C346-03** Core Extractor Ø 150 mm

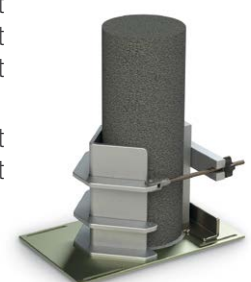
**B040-21****B040-21**

**B040**
**APS**
**AUTOMATIC PAVE SAW**

**DUAL BLADE CONCEPT FOR PERFECT PARALLEL CUTTING**

Matest has developed a dual bladed automated sawing system for fast, accurate cutting of cores, prisms and slabs prepared using Matest's range of asphalt compaction machines; GYROTRONIC-Gyratory Compactor, ASC-Asphalt Shear-box Compactor and ARC-Asphalt Roller Compactor for Four Point Bending (4PB), Two Point Bending (2PB), Overlay tester (OT), Semi Circular Bending (SCB) and wheel tracking tests using Matest/ Pavetest's range of leading edge testing systems.

It includes: **cooling water recirculation pump, tank and protection cabinet with interlocks to ensure operator safety.**

**B040**

**MAIN FEATURES**

- Two saw blade design ensures for perfect parallel cutting.
- Motorized feed with automatic retraction of saw carriage.
- Electronic control unit with touch screen colour display, that runs like a standard PC based on Windows operating system.
- Adjustable cutting speed.
- Slabs and prisms can be sawn safely and accurately.
- Jigs also available for trimming 100 and/or 150mm diameter cylinders/cores.
- Facilitates cutting rectangular beams, trapezoidal prisms, overlay test specimens, semi-circular & wheel tracking specimens, and cylindrical specimens.
- Simple spacer system allows precise preparation of beams and cylinders from 38mm to 160mm long, without the need for measurement.
- Other dimensions can be accommodated using integral ruler.
- Adjustable limit switches facilitates repetitive cutting with minimal saw carriage travel. Secure specimen clamping. Choice of mechanical or pneumatic.
- Protective enclosure, with safety interlocks, combines clean operation with unparalleled operator safety.
- Dynamic breaking system stops saw blade rotation when power is switched off.

## THE NEXT GENERATION FULLY AUTOMATED ASPHALT SAWING SYSTEM

Matest's new APS-Automatic Pave Saw is the next generation fully automated asphalt sawing system with integrated specimen clamping. **The APS offers fast and accurate cutting of rectangular beams, trapezoidal prisms, overlay test specimens, semi-circular specimens, and trim- ming of cylindrical specimens.**

**The APS uses two blades** to ensure perfect parallel cutting of cylinders and beams at set intervals from 38 to 160 mm long. If equipped with proper blades, the APS cuts not only asphalt but also several other materials.

The APS is controlled using Matest's tried and proven **iTouch electronic** control unit with touch screen colour display for perfect cutting of specimens for AASHTO, ASTM and EN standards without the need for manual measurements. **It is the safest and most advanced asphalt cutting saw** available on the market and is the perfect companion to our range of advanced asphalt preparation and testing equipment.

The APS is capable of cutting prismatic specimens up to 240mm high and a cutting length up to 700mm and cylindrical specimens up to 200mm diameter. **The APS can be configured using one or two blades, with a large range of jigs and fixtures** to cut rectangular beams, trapezoidal prisms, overlay test specimens, semi-circular & wheel tracking specimens, and trim cylindrical specimens accurately, with excellent parallelism and perpendicularity. Various alignment blocks, guides and reference spacers allow operators to easily achieve the most commonly used dimensions specified in a range of international standards with little or no measurement. Any other dimensions can be accommodated with the aid of an integrated ruler.

The **iTouch controller** allows the operator to easily control the cutting speed and sequence and a series of adjustable limit switches minimizes the saw carriage travel during repetitive cutting. The high grade stainless steel work surface and associated corrosion resistant components ensures the unit will perform well and look good for many years.

The **protective enclosure** provides a high level of operator safety and protection from water spray. Safety interlocks prevent the operator from opening the enclosure and accessing hazardous areas while the blade is rotating. Once the cutting sequence has finished and the blade has stopped rotating, the enclosure is unlocked automatically.

### ACCESSORIES

- B040-01** APS DIAMOND BLADE, 650 mm diameter (q.ty 1 or 2) or
- B040-02** APS DIAMOND BLADE, 700 mm diameter (q.ty 1 or 2)
- B040-03** SET OF SPACERS for mounting the APS Diamond blade, 650 mm diameter (needed for B040-01)
- B040-04** SET OF SPACERS for two blades configuration (needed for two blades configuration)
- B040-05** SPACER for one blade configuration (needed for one blade configuration)
- B040-06** DISPLACEMENT TRANSDUCER for the control of the blade position
- B040-07** PNEUMATIC CIRCUIT (needed with Pneumatic cutting jigs)

If equipped with pneumatic cutting jigs, the unit requires compressed air, minimum 8 bar



### SPECIFICATIONS

- One or two blade concept
- Blade Diameter(s): 650 mm or 700 mm
- Blade Speed 1,400rpm (50Hz) or 1,680rpm (60Hz)
- Adjustable cutting speed, min 40 mm/min max 200 mm/min
- Max Cutting Depth 200 mm (with 650 mm blade diameter) or 240 mm (with 700 mm blade diameter)
- Cores 100 or 150 mm diameter (38 mm or 200 mm diameter on request )
- Max Prism Length 700 mm
- Cooling water recirculation pump and tank included
- Net Weight 500 kg approx.
- Parallel (Dual blade) cutting distance: 38 mm to 160 mm at set distances
- Dimensions 2370 mm (L) x 1340 mm (D) x 1670 mm (H)
- Air Supply 600 kPa (for pneumatic clamping option)
- Power Supply:
  - 400V 50Hz 3ph, 230V/220V 50Hz 3ph (B040)
  - 400V 60Hz 3ph, 230V/220V 60Hz 3ph (B040X)
  - 208V 60Hz 3ph (B040Z)

### CUTTING JIGS

- B040-10M** APS manual Multi-Slab/Prism jig suitable for slabs and prisms with the following dimensions: 40 - 240 mm depth x 700 mm length.
- B040-10P KIT** APS automatic Multi-Slab/Prism jig suitable for slabs and prisms with the following dimensions: 40 - 240 mm depth x 700 mm length.
- B040-12M** APS manual trapezoidal specimen jig for two point bend (it requires B040-10M or B040-10P-KIT).
- B040-13M** APS manual core docking jig for Ø 150-100-60-50-40-38 mm cores.
- B040-13P** APS automatic core docking jig for Ø 150-100-60-50-40-38 mm cores.
- B040-14** Instrumentation for Overlay test, wheel tracking core, semi-circular and disk shaped compact tension specimens (it requires B040-13M or B040-13P).

**B039A**
**ASC**
**ASPHALT SHEAR BOX COMPACTOR**

THE ONLY ELECTROMECHANICAL SHEAR BOX COMPACTOR

**NEW STANDARD: ASTM D7981-15** Standard practice for compaction of prismatic asphalt specimens by means of the Shear Box Compactor.

 The ASC is being **used in FHWA Contract** "Deployment of Performance-Based Technologies for Mechanistic-Empirical Pavement Design and Resource Responsible Materials Design" to fabricate specimens for Level 1 analyses using the AASHTOWare Pavement ME Design software.

It is the only compactor capable of fabricating specimens for all of the following mechanistic-empirical performance tests:

**Dynamic Modulus**, AASHTO PP 61

**Repeated Load Permanent Deformation**, AASHTO TP 79

**Flexural Fatigue**, AASHTO T321

**Low Temperature Creep and Strength**, AASHTO T322

**MAIN FEATURES**

- Extremely sturdy fabricated frame combined with precision machined components.
- Servo hydraulic vertical ram with integral hydraulic power supply.
- Precision electro-mechanical shearing motion (user programmable).
- Integral specimen extruder.
- Electronic control unit with touch screen color display (no need for PC).
- Unlimited memory storage with: 2 USB ports, 1 SD card slot, RS232/485 serial port.
- The compaction cycle can be programmed by specifying vertical stress/load and test termination conditions; Number of cycles, Specimen height and/or density.
- Precision load cell(s) for vertical and shear stress measurement.
- Optional built-in mould heater.

**THE MOST UNIFORM DENSITY OF ANY MACHINE**

Specimen is extruded after the machine has completed the specified number of cycles, or when the required specimen height has been reached.

An automatic extruder allows an easy extraction of the compacted specimen.

**B039A**

## TECHNICAL SPECIFICATION

<b>Vertical force</b>	Up to 100kN
<b>Shearing force</b>	Up to 50kN
<b>Shear angle</b>	$4^\circ \pm 0.1^\circ$
<b>Shearing cycle rate</b>	$3 \pm 0.1$ gyrations per minute
<b>Mould width</b>	$150\text{mm} \pm 0.1 \text{ mm}$
<b>Mould length</b>	$450\text{mm} \pm 0.1 \text{ mm}$
<b>Mould surface finish (inside)</b>	Smoother than $0.4\mu\text{m rms}$
<b>Mould surface hardness</b>	More than 48 Rockwell C
<b>Mould capacity</b>	Approx. 20 litres
<b>Loading platen width</b>	$149 \text{ mm} \pm 0.2 \text{ mm}$
<b>Loading platen length</b>	$449 \text{ mm} \pm 0.2 \text{ mm}$
<b>Loading platen smoothness</b>	Smoother than $0.4\mu\text{m rms}$
<b>Loading platen surface hardness</b>	More than 48 Rockwell C
<b>Number of cycles</b>	Up to 100
<b>Vertical stress</b>	$0.1 \text{ to } 1.5\text{MPa} \pm 0.01\text{MPa}$
<b>Compaction height</b>	$0 \text{ mm to } 200 \text{ mm} \pm 0.1\text{mm}$

Power supply: 230V 1ph 50-60Hz  
 Dimensions: 788x1360x1314 mm  
 Weight: 1200 kg approx.

## A RUGGED DESIGN FOR THE BEST SPECIMEN PREPARATION

Asphalt technologists are acutely aware of the **importance of a representative specimen** during any laboratory performance testing. The **precise shearing motion** of the ASC replicates the conditions of field compaction in order to reproduce the field properties of asphalt, quickly and easily under the controlled conditions of a laboratory. The ASC **compacts large asphalt prisms** that can be sawn to produce four to six beams or slabs for laboratory wheel tracking; or the prism can be cored to produce three to four 100 mm diameter cylinders, all having essentially identical properties.

The electronic control unit, with touch screen color display, makes a PC an option, not a necessity.

The **user friendly touch-screen** icon interface allows for easy set up parameter entry, enables immediate (fully automatic test execution) data acquisition/processing, test report, and data file generation.

A LAN connection to Intranet/Internet enables remote communication to receive immediate diagnostic analysis and technical support from Matest technicians, and/or software updates

## ACCESSORIES

- B039A-01** LOADING CHUTE
- B039A-02** TRAY (2 off)
- B039A-03** SPREADING COMB
- B039A-04** LEVELING BLADE
- B039A-05** BUILT-IN MOULD HEATER (optional)

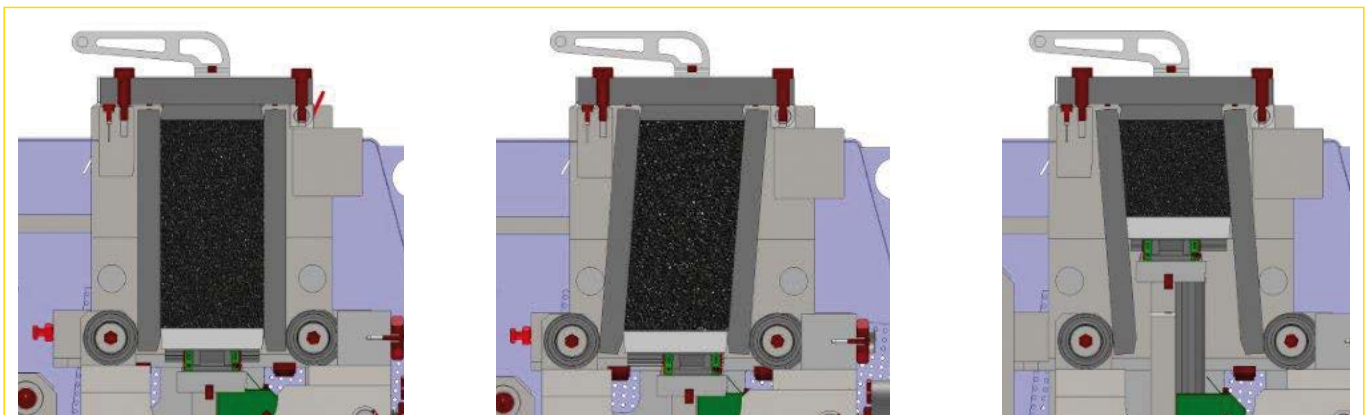

During the compaction process a lateral displacement is applied to the specimen along with a vertical load, which results in a shearing action that makes the compaction similar to the the field.

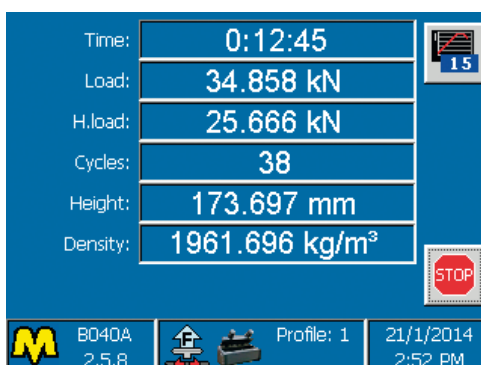

Test parameters during compaction

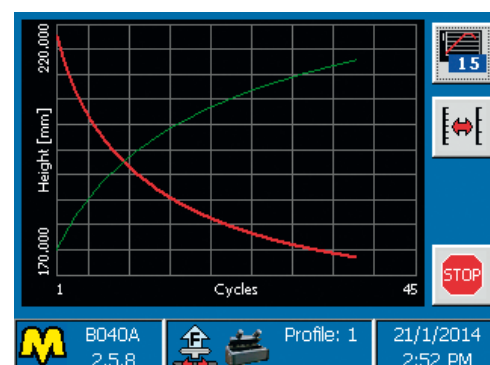

Height-Cycles and Density-Cycles curves during compaction

## CYCLIC TriaxLab Automated System

STANDARDS: ASTM D7181 | ASTM D2850 | ASTM D3999 | ASTM D4767 | ASTM D5311 | BS 1377:7 | BS 1377:8 | AASHTO T307-9



### MAIN FEATURES

- Automatic execution of static and dynamic triaxial tests including effective stress and stress path.
- Servo feedback controlled precision pressure (Pressurematic) generation system.
- Digital Servo-Pneumatic Control to provide accurate loading wave shapes up to 70 Hz.
- Possibility to upload user-defined wave-shapes (e.g. earthquakes time series) through Replay Editor.
- Fully configurable to suit a large range of testing applications including maximum shear modulus calculation through bender elements option.
- Programmable Dashboard display showing real-time system status charting and test result.



DTS-9 Cyclic TriaxLab Automated System

The Cyclic TriaxLab automated with its innovative features represents the most ideal solution for modern laboratories that need to investigate the effects of vibration and dynamic loading for soil and unbound granular materials.

Typical applications include: civil engineering including seismic and blasting analysis; environmental engineering; construction and architectural design and advanced research on soils.

Based on the 4 axis control and 16 channel control and Data Acquisition CDAS, Matest Cyclic TriaxLab has provision for:

- Vertical load tension/compression up to 9 kN
- Vertical displacement up to 50 mm
- Cell pressure up to 2000 KPa
- Back pressure up to 2000 KPa

The Cyclic TriaxLab automated system is subdivided into 3 major groups similarly to the TriaxLab Automated System:

- **Fully digital controlled load frame** and fit for purpose Triaxial cell with accessories
- **Control system** based on the CDAS
- **Data Acquisition System** comprising:
  - 1 submersible load cell for axial force
  - 3 pressure transducers for cell pressure, back pressure and pore pressure
  - 2 Pressurematic for pressure/volume change

To suit the specific customer's requirements the Cyclic TriaxLab Automated System basic configuration can be modified by adding or removing the hardware elements which are controlled and monitored under a closed-loop integrated system with the CDAS and TestLab Software. Pre-programmed "Method files" offer the operator the unique opportunity to run a range of tests without the need for specific computer programming. The possibility to customize the Method files is also given to the operator granting ultimate flexibility and versatility.

## CYCLIC TriaxLab Automated System ORDERING INFO:

### HARDWARE - SOFTWARE

#### B220-04 KIT DTS9 WITH MANUAL CROSSHEAD

The machine includes:

##### B220-14

20 kN load frame with manual crosshead  
9 kN servo-pneumatic actuator with its LVDT,  
50mm stroke, 70 Hz frequency.

**Power supply:** 90-264V 50-60Hz 1ph 240W

**Dimensions:** 1262(h)x400(d)x470(w)

**Weight:** 80 kg load frame

##### S303

16 Channel Control and Data Acquisition  
System (CDAS) and TestLab software.

For technical specifications, see p. 564

##### B270-12

Air reservoir assembly with membrane dryer.  
It requires pressurized air, minimum 7 bar  
(not included).

##### S307

#### TRIAXIAL CELL MAX Ø 150X300 MM

Technical specifications:

- Max specimen mm Ø 150x300
- Max cell pressure 2200 kPa
- Overall dimensions mm Ø 338x648
- Weight 40 kg approx.

Accessories listed at p. 546

**Note:** Triaxial cell for cyclic tests  
max. 100x200 mm available on request.



S307 with accessories

### MEASURE OF AXIAL FORCE

#### S337-06 SUBMERSIBLE LOAD CELL 10 KN WITH SIGNAL CONDITIONER

■ Rated output 2 mV/V nominal

■ Accuracy 0.1%

**Note:** For different requirements load  
cells capacity and transducers stroke or  
submersible load cells, see p. 548

#### ACCESSORIES FOR TRIAXIAL CELL

**S337-23** Loading ram for the submersible  
load cell

**S307-05** Transducers holder ring

**S307-10** Vacuum generator

**S307-19** Vacuum adaptor

**S307-11** Alignment coupler assembly

**S307-12** Spherical exclusion

**S307-13** Base pedestal spacer

#### OPTIONAL ACCESSORIES

BENDER ELEMENTS KIT for the evaluation of  
the stiffness of a soil starting from the meas-  
urement of the maximum shear modulus  
(Gmax). The Kit includes:

**S307-08** Picoscope

**S307-07** T-4001 waveforms transformer

**S307-01** Universal puck for bender  
elements top

**S307-02** Universal puck for bender  
elements bottom

**S307-22 | 32 | 42 | 52**

Base pedestal for bender element  
Ø 38 | 50 | 70 | 100 mm

**S307-23 | 33 | 43 | 53**

Top platen for bender element  
Ø 38 | 50 | 70 | 100 mm

**S307-24 | 34 | 44 | 54**

Pair of porous disc  
Ø 38 | 50 | 70 | 100 mm



Bender elements KIT

### DEAIRED WATER SYSTEM

#### S355 DE-AIRING TANK 20 LITRES CAPACITY

It produces de-aired water when connected  
to the vacuum pump. It is a Perspex tank with  
an inlet water valve and an outlet air valve.  
Tank capacity: 20 litres.

**Dimensions:** 320x320x520 mm

**Weight:** 15 kg approx.

#### ACCESSORIES

##### V205

VACUUM PUMP

To produce vacuum up to of 0.1 mbar  
(see p. 597)

##### V205-10 - V205-12

VACUUM REGULATOR

It is supplied with vacuum gauge, control  
valve, suction filter and moisture trap.

##### V230-03

Rubber tube. Suitable for vacuum, 3 m

### MEASURE OF PORE PRESSURE SYSTEM AND VOLUME CHANGE

#### S349 PRESSUREMATIC PVC FOR AUTOMATIC PRESSURE AND VOLUME CONTROL

Output pressure: 3500 kPa

Volume capacity: 250 cc

For Technical Specifications, see p. 565

#### NEEDED ACCESSORIES

**S336-53** Pressure transducer 2000 kPa  
with signal conditioner.

**S336-55** De-airing block for pressure  
transducer

**S349-10** Solenoid valve

#### OPTIONAL ACCESSORIES

**S342-03** 3 ways water distribution panel







**PAVETEST IS A DIVISION OF MATEST**  
COMMITTED TO DEVELOPING  
INNOVATIVE DYNAMIC TESTING SYSTEMS.



**#GROWINGLEADER**  
Since 2012  
[www.pavetest.com](http://www.pavetest.com)